

NEW



GENESYSTM G Series

Programmable DC Power Supplies

Full-Rack 1kW/1.7kW/2.7kW/3.4kW/5kW/7.5kW in 1U Height

GSP 10kW/15kW in 2U/3U Height

! Advanced Features Built-In !

- **Arbitrary Waveform Generator with Auto-Trigger Capability**
 - **Programmable Slew Rate Control (Vout/Iout)**
- **Constant Power Limit Operation** • **Internal Resistance Programming**
 - **Built-In Remote Isolated Analog Interface**
- **Built-In LAN (LXI 1.5), USB, and RS-232/RS-485 Interfaces**
- **Optional EtherCAT, Modbus-TCP, IEEE (488.2) Interfaces**
 - **Blank Front Panel Option Available**



TDK-Lambda

Trusted • Innovative • Reliable

The **GENESYS™** family of programmable power supplies sets a new standard for flexible, reliable, AC/DC power systems in OEM, Industrial and Laboratory applications.

Features include:

- Leading DC Programmable power density (7.5kW in 1U height, 10kW/15kW in 2U/3U height) in 19" rack-mount
- Light-weight 5kW<7.5 kg, 7.5kW<8.5 kg, GSP 10kW<15.5 kg, 15kW<23.5 kg
- Wide Range of popular worldwide AC inputs:
G1kW/1.7kW: 1 ϕ (85~265VAC)
G2.7kW / G3.4kW: 1 ϕ (170~265VAC), 3 ϕ (208VAC, 400VAC)
G5kW / G7.5kW / GSP10kW / 15kW: 3 ϕ (208VAC, 400VAC & 480VAC), Wide-range 3 ϕ 480VAC (342VAC ~ 528VAC)
- Active PFC (0.94 typical)
- Output Voltage up to 1500V, Current up to 1500A
- Built-in LAN (LAN 1.5), USB, RS-232/RS-485 Interface
- Multi-Drop capability (RS-485)
- Multi-functional front panel display
- Last-Setting Memory
- Auto-Start / Safe-Start: user selectable
- High Resolution 16 bit ADCs & DACs
- Arbitrary Waveform Generator with Auto-Trigger Capability
- Store up to 100 steps into four internal memory cells
- High-speed Programming
- Constant Voltage/Constant Current operation modes
- Constant Power (CP) Limit
- Slew-Rate Control (V/I)
- Internal Resistance Programming Simulation
- Local / Remote Sensing - software controlled
- Built-In Remote Isolated Analog Program/Monitor and Control Interface
- Protection functions (OVP, UVP, UVL, FOLD (CV/CC), OCL, OTP, AC FAIL)
- Fan speed controlled by ambient temperature and load
- Certified LabWindows™/CVI, LabVIEW™, and IVI Drivers
- Optional EtherCAT, Modbus-TCP, IEEE (488.2) Interfaces
- 19" Rack Mount capability for ATE and OEM application
- Scalable Power Systems of 10kW and 15kW
- Parallel Systems (up to 60kW) with Auto-Configure
- Worldwide Safety Agency approvals
- CE Mark for Low Voltage, EMC and RoHS3 Directives
- Five year warranty

Applications

GENESYS™ power supplies have been designed to meet the demands of a wide variety of applications.

Test & Measurement systems, Component Device Testing, Manufacturing and process control.

Semiconductor Processing & Burn-In, Aerospace & Satellite Testing, Medical Imaging, Green Technology.

Higher power systems can be configured with up to twelve (12) 7.5kW units. Each unit is 1U with zero space between them (zero stack).

OEM Designers have a wide variety of Inputs and Outputs from which to select depending on application and location.

G1kW-7.5kW Front Panel Description



1. Input Power ON/OFF Switch
2. Air Intake allows zero stacking for maximum system flexibility and power density.
3. Reliable Detent Encoders for settings and Menu navigation.
4. High Contrast/Brightness display with wide viewing angle, 16 segment LCD
5. Function/Status LEDs: Active modes and function indicators
6. Pushbuttons allow flexible user configuration

G1kW-5kW Rear Panel Description



1. Isolated Analog Programming, Monitoring and other control connector (DB26 Female)
2. USB Interface connector (Type B).
3. RS-232/RS-485 IN/OUT Remote Digital Interface (RJ-45 type) for Multi-Drop connection
4. LAN (LXI 1.5) Interface connector (RJ-45 type with LAN status indicators).
5. Auto paralleling Bus connectors (mini I/O type) for connecting Master Unit-to-Slave and Slave Unit-to-Slave unit.
6. Remote/Local Output Voltage Sense Connections (spring cage).
7. Output Connections: Rugged busbars (shown) for models up to and including 100V Output; Plug connector: PHOENIX CONTACT IPC 5/4-STF-7.62 for models with Outputs >100V.
8. G2.7kW / G3.4kW / G5kW AC Input: 208VAC, 400VAC & 480VAC, Three Phase, 50/60 Hz. (Model shown) AC Input Plug Connector: PHOENIX CONTACT Power Combicon PC 5/4-STCL1-7.62 Series with strain relief. G1.7kW / G2.7kW / G3.4kW AC Input Single Phase, 50/60 Hz. AC Input Plug Connector: PHOENIX CONTACT Power Combicon PC 5/3-STCL1-7.62 Series with strain relief. G1kW AC Input Connector: IEC320 C16.
9. Optional Interface Position for IEEE 488.2 SCPI or AnyBus Interface.
10. Exhaust air assures reliable operation when units are zero stacked.
11. Functional Ground connection (M4x8mm stud).
12. Reset button. Set default Power Supply settings.
13. G+ 5kW 1000V and 1.500V has the same housing as 7.5kW

G7.5kW Rear Panel Description



1. Isolated Analog Programming, Monitoring and other control connector (DB26 Female)
2. USB Interface connector (Type B).
3. RS-232/RS-485 IN/OUT Remote Digital Interface (RJ-45 type) for Multi-Drop connection
4. LAN (1.5) Interface connector (RJ-45 type with LAN status indicators).
5. Auto paralleling Bus connectors (mini I/O type) for connecting Master Unit-to-Slave and Slave Unit-to-Slave unit.
6. Remote/Local Output Voltage Sense Connections.
Plug connector: PHOENIX CONTACT - GIC 2,5 HCV/ 3-ST-7,62 - 1745632
7. Output Connections: Rugged busbars (shown) for models up to and including 1500V Output;
8. G7.5kW: AC Input: 480VAC, Three Phase, 50/60 Hz. (Model shown)
AC Input Plug Connector: PHOENIX CONTACT Power Combicon PC 5/4-STCL1-7.62 Series with strain relief.
AC Input: 208VAC, Three Phase, 50/60 Hz.
AC Input Plug Connector: PHOENIX CONTACT DFK-IPC 16/4-STF-10.16 with strain relief.
9. Optional Interface Position for IEEE 488.2 SCPI or AnyBus Interface.
10. Exhaust air assures reliable operation when units are zero stacked.
11. Functional Ground connection (M4x8mm stud).
12. Reset button. Set default Power Supply settings.

GSP10kW Front Panel Description



1. Input Power ON/OFF Switch
2. Air Intake allows zero stacking for maximum system flexibility and power density.
3. Reliable Detent Encoders for settings and Menu navigation.
4. High Contrast/Brightness display with wide viewing angle, 16 segment LCD
5. Function/Status LEDs: Active modes and function indicators
6. Pushbuttons allow flexible user configuration

GSP10kW Rear Panel Description

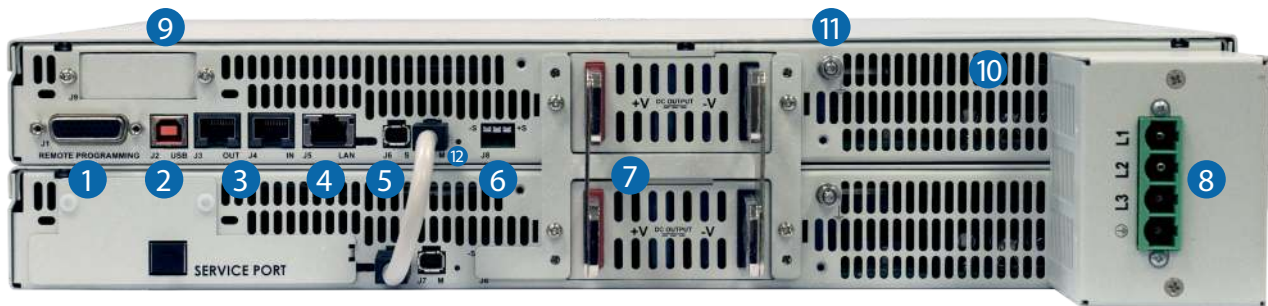

1. Isolated Analog Programming, Monitoring and other control connector (DB26 Female)
2. USB Interface connector (Type B).
3. RS-232/RS-485 IN/OUT Remote Digital Interface (RJ-45 type) for Multi-Drop connection
4. LAN (**LXI** 1.5) Interface connector (RJ-45 type with LAN status indicators).
5. Auto paralleling Bus connectors (mini I/O type) for connecting Master unit-to-Slave and Slave unit-to-Slave unit.
6. Remote/Local Output Voltage Sense Connections (spring cage).
7. Output Connections: Rugged busbars (shown) for models up to and including 100V Output; Plug connector: PHOENIX CONTACT DFK-IPC 16/4-STF-10.16 for models with Outputs >100V.
8. Input: 208VAC, 400VAC & 480VAC Three Phase, 50/60 Hz.
AC Input Plug Connector: PHOENIX CONTACT DFK-IPC 16/4-STF-10.16 with strain relief.
9. Optional Interface Position for IEEE 488.2 SCPI or AnyBus Interface.
10. Exhaust air assures reliable operation when zero stacked.
11. Functional Ground connection (M4x8mm stud).
12. Reset button. Set default Power Supply settings.

GSP15kW Front Panel Description

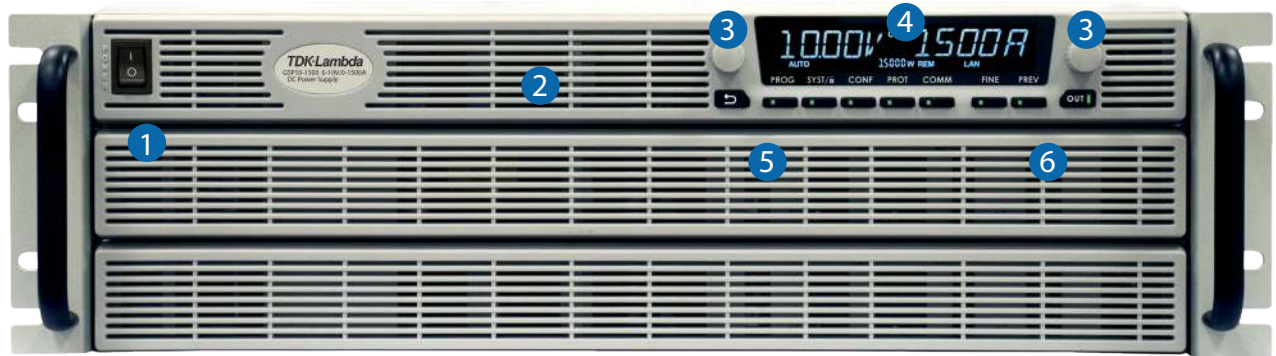

1. Input Power ON/OFF Switch
2. Air Intake allows zero stacking for maximum system flexibility and power density.
3. Reliable Detent Encoders for settings and Menu navigation.
4. High Contrast/Brightness display with wide viewing angle, 16 segment LCD
5. Function/Status LEDs: Active modes and function indicators
6. Pushbuttons allow flexible user configuration

GSP15kW Rear Panel Description

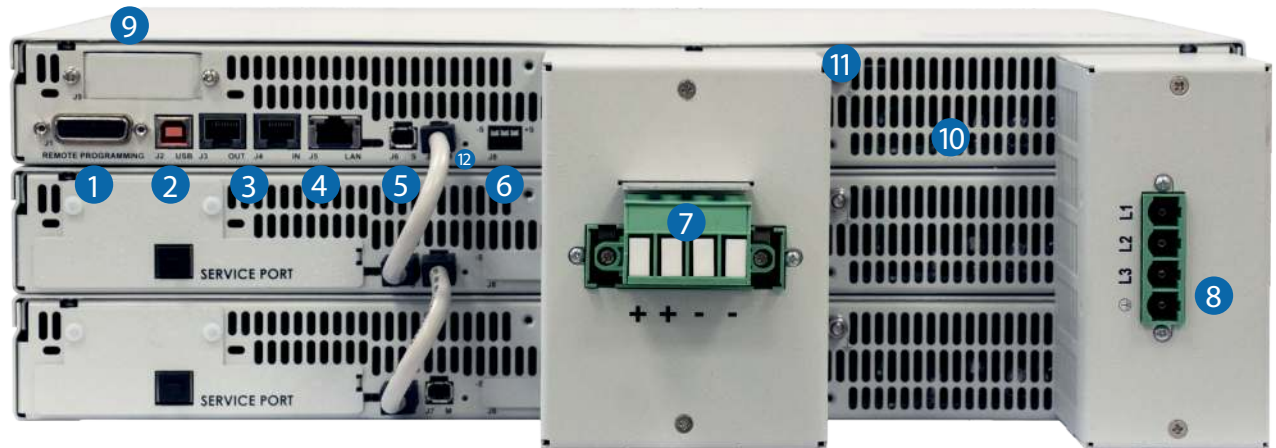

1. Isolated Analog Programming, Monitoring and other control connector (DB26 Female)
2. USB Interface connector (Type B).
3. RS-232/RS-485 IN/OUT Remote Digital Interface (RJ-45 type) for Multi-Drop connection
4. LAN (LXI 1.5) Interface connector (RJ-45 type with LAN status indicators).
5. Auto paralleling Bus connectors (mini I/O type) for connecting Master unit-to-Slave and Slave unit-to-Slave unit.
6. Remote/Local Output Voltage Sense Connections (spring cage).
7. Output Connections: Rugged busbars for models up to and including 100V Output;
Plug connector: PHOENIX CONTACT DFK-IPC 16/4-STF-10.16 for models with Outputs >100V (shown).
8. Input: 208VAC, 400VAC & 480VAC Three Phase, 50/60 Hz.
AC Input Plug Connector: PHOENIX CONTACT DFK-PC 16/4-ST-10.16 with strain relief.
9. Optional Interface Position for IEEE 488.2 SCPI or AnyBus Interface.
10. Exhaust air assures reliable operation when zero stacked.
11. Functional Ground connection (M4x8mm stud).
12. Reset button. Set default Power Supply settings.

Front Panel Display MENU/CONTROL buttons:

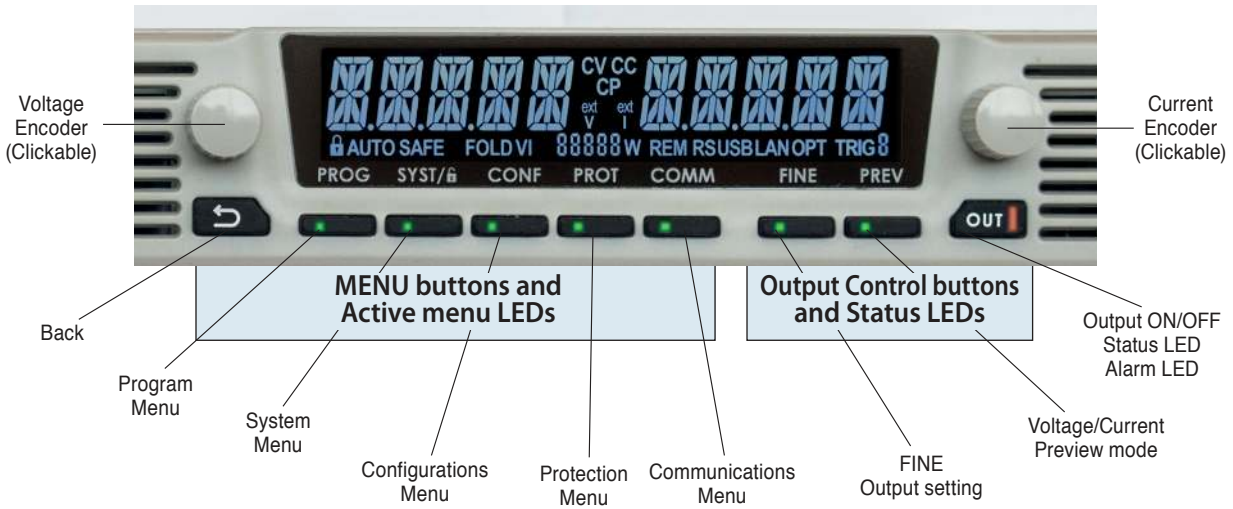

Front Panel Display indicators

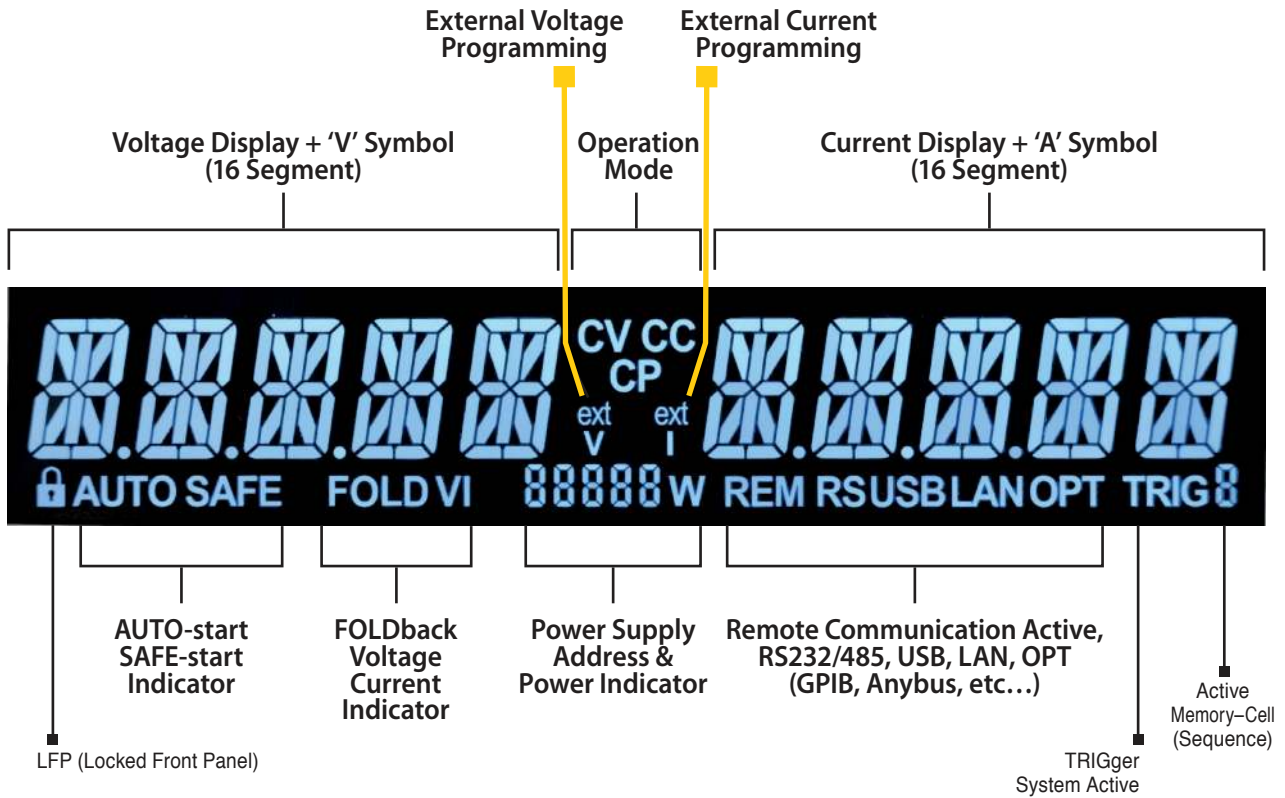

**GENESYS™ G&GSP Series
Blank Front Panel (ATE version)**



A Blank Front Panel is available for applications where the front panel display and controls are not required and only remote interface (Digital/Analog) is needed. The Blank Front Panel option has all the standard product functions and features except the display. The power supply can be controlled via the rear panel Remote digital interface (LAN, USB, RS-232/RS-485) or via the remote Isolated Analog interface.

GENESYS™ Parallel and Series Configurations

Parallel operation - Master/Slave:

Auto paralleling Scalable Master-Slave Operation. Active current sharing allows up to twelve (12) identical units to be connected. Total real current is programmed measured and reported by the Master. Up to twelve (12) supplies operate as one.

Separate Parallel Kit available for 30kW (6 unit) systems allowing easy system setup.
Order P/N: G/P - 6U

Series operation

Two units may be connected in series to increase the output voltage or to provide bipolar output. (Max 600V to Chassis Ground).

Multi-Drop Remote Programming via Communication Interface

Standard Built-in LAN, USB, RS-232 & RS-485 allows "Multi-Drop" daisy-chain control of up to 31 Power supplies on the same communication bus. Can be Daisy chained via built-in RS-485 Interface.

- First unit is LAN, USB, RS-232, RS-485, etc.
- All other units use RS-485 daisy chain with linking cable.

Standard Unit - zero stacked up to 12 units



Standard & Blank - zero stacked up to 12 units



LAN, USB, RS-232, RS-485, IEEE, AnyBus

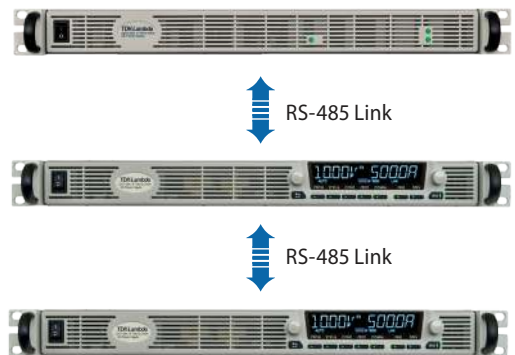

Graphical User Interface

Advanced "Virtual Control Panel" allows programming and monitoring unit(s) with or without front panel display.

1. 1. Control and monitor DC Programmable Power Supply Series (GENESYS+, GENESYS and Z+).
2. 2. Automatically detect power supplies connected to a PC and/or local network.
3. 3. Advanced Terminal, including Modbus-TCP and EtherCAT communication interfaces.
4. 4. Real-time Graph and Waveform creator, including pre-built functions i.e. Sine, Triangle and Square.
5. 5. Solar array simulation based on VOC, VMP, IMP, ISC.
6. 6. Advanced functions control – Slew-Rate, Internal Resistance and Constant Power.
7. 7. Multi-Model Monitoring and Control Panel.
8. 8. Individual and Global commands control.

GUI Waveform Profile Generator

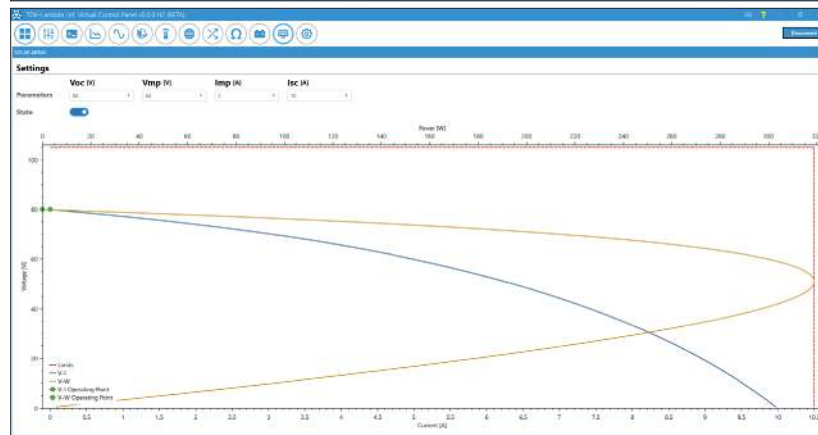
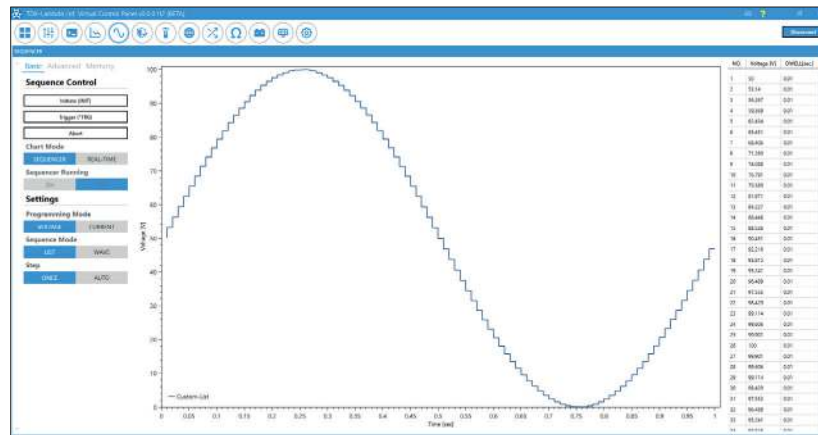
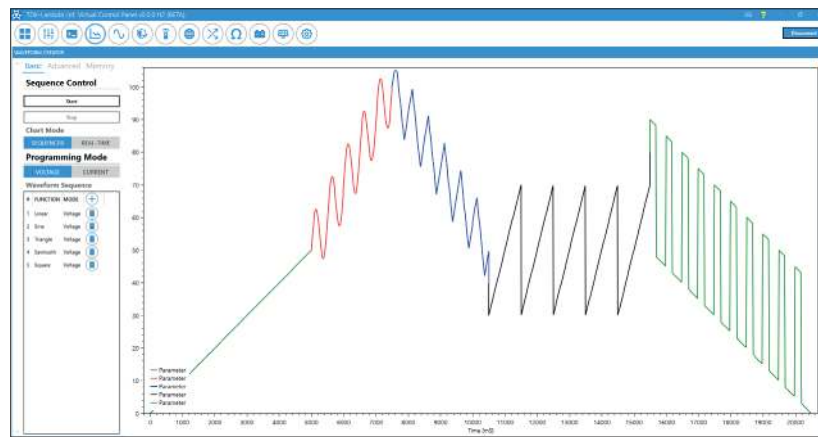

How to order G1kW/1.7kW - Power Supply Identification / Accessories

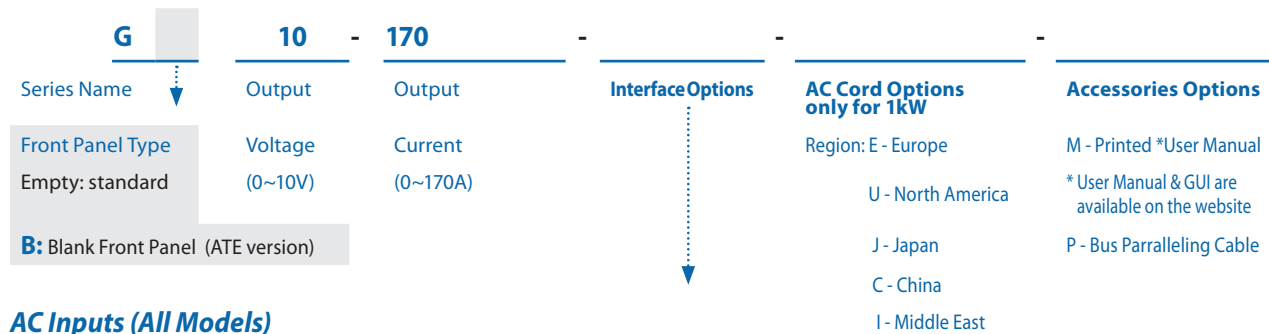

AC Inputs (All Models)

1Ø, 85 ~ 265Vac

Interface Options (Factory installed)

LAN (LX) 1.5 compliant with Multi-Drop capability)- built-in
 USB 2.0 compliant with Multi-Drop capability - built-in
 RS-232/RS-485 - built-in
 Isolated Analog Program/Monitor Interface
 (5V/10V Pgm/Mon with 600V isolation) - built-in
 IEEE (488.2 & SCPI compliant with Multi-Drop capability installed)
 Modbus-TCP
 EtherCAT
 Isolated Analog Current Program/Monitor Interface
 (4mA-20mA with 600V isolation)

P/N

-
-
-
-
IEEE
MDBS
ECAT
IS420

Models 1kW

Model	Voltage (V)	Current (A)	Power (W)
G10-100	0~10V	0~100	1000
G20-50	0~20V	0~50	1000
G30-34	0~30V	0~34	1020
G40-25	0~40V	0~25	1000
G60-17	0~60V	0~17	1020

Model	Voltage (V)	Current (A)	Power (W)
G80-12.5	0~80V	0~12.5	1000
G100-10	0~100V	0~10	1000
G150-7	0~150V	0~7	1050
G300-3.5	0~300V	0~3.5	1050
G600-1.7	0~600V	0~1.7	1020

Models 1.7kW

Model	Voltage (V)	Current (A)	Power (W)
G10-170	0~10V	0~170	1700
G20-85	0~20V	0~85	1700
G30-56	0~30V	0~56	1680
G40-42	0~40V	0~42	1680
G60-28	0~60V	0~28	1680

Model	Voltage (V)	Current (A)	Power (W)
G80-21	0~80V	0~21	1680
G100-17	0~100V	0~17	1700
G150-11.2	0~150V	0~11.2	1680
G300-5.6	0~300V	0~5.6	1680
G600-2.8	0~600V	0~2.8	1680

Accessories

Accessories will be sent separately from the Power Supply packing, according to order.

1. Serial Communication cable. RS-232/RS-485 cable is used to connect the power supply to the Host PC.

Mode	RS-485	RS-232
PC Connector, Communication Cable, Power Supply Connector	DB-9F. Shielded L=2m. RJ-45	DB-9F. Shielded L=2m, RJ-45
P/N	GEN/485-9	GEN/232-9

2. Serial link cable (Included with the power supply)

Daisy-chain up to 31 GENESYS™ power supplies.

Mode	Power Supply Connector	Communication Cable	P/N
RS-485	RJ-45	Shielded L=50cm	GEN/RJ45

3. Bus Paralleling cable

Connectors	Cables	P/N
2013595-1 (TYCO)	Shielded L=11cm	G/P

4. User Manual

Printed User Manual	P/N
	G/M

How to order G2.7kW / 3.4kW - Power Supply Identification / Accessories

G	10	340	-	-	-
Series Name	Output	Output	Interface Options		AC Input Options
Front Panel Type	Voltage	Current	P/N		
Empty: standard	(0~10V)	(0~340A)			
B : Blank Front Panel (ATE version)					Accessories Options

Interface Options (Factory installed)

LAN (LAN 1.5 compliant with Multi-Drop capability) - built-in	-
USB 2.0 compliant with Multi-Drop capability - built-in	-
RS-232/RS-485 - built-in	-
Isolated Analog Program/Monitor Interface (5V/10V Pgm/Mon with 600V isolation) - built-in	-
IEEE (488.2 & SCPI compliant with Multi-Drop capability installed)	IEEE
Modbus-TCP	MDBS
EtherCAT	ECAT
Isolated Analog Current Program/Monitor Interface (4mA-20mA with 600V isolation)	IS420

Models G2.7kW

Model	Output Voltage VDC	Output Current (A)	Output Power (W)	Model	Output Voltage VDC	Output Current (A)	Output Power (W)
G10-265	0~10V	0~265	2650	G80-34	0~80V	0~34	2720
G20-135	0~20V	0~135	2700	G100-27	0~100V	0~27	2700
G30-90	0~30V	0~90	2700	G150-18	0~150V	0~18	2700
G40-68	0~40V	0~68	2720	G300-9	0~300V	0~9	2700
G60-45	0~60V	0~45	2700	G600-4.5	0~600V	0~4.5	2700

Models G3.4kW

Model	Output Voltage VDC	Output Current (A)	Output Power (W)	Model	Output Voltage VDC	Output Current (A)	Output Power (W)
G10-340	0~10V	0~340	3400	G80-42	0~80V	0~42	3360
G20-170	0~20V	0~170	3400	G100-34	0~100V	0~34	3400
G30-112	0~30V	0~112	3360	G150-22.5	0~150V	0~22.5	3375
G40-85	0~40V	0~85	3400	G300-11.5	0~300V	0~11.5	3450
G60-56	0~60V	0~56	3360	G600-5.6	0~600V	0~5.6	3360

Accessories

Accessories will be sent separately from the Power Supply packing, according to order.

1. Serial Communication cable. RS-232/RS-485 cable is used to connect the power supply to the Host PC.

Mode	RS-485	RS-232
PC Connector, Communication Cable, Power Supply Connector	DB-9F. Shielded L=2m. RJ-45	DB-9F. Shielded L=2m, RJ-45
P/N	GEN/485-9	GEN/232-9

2. Serial link cable (Included with the power supply)

Daisy-chain up to 31 **GENESYS™** power supplies.

Mode	Power Supply Connector	Communication Cable	P/N
RS-485	RJ-45	Shielded L=50cm	GEN/RJ45

3. Bus Paralleling cable

Connectors	Cables	P/N
2013595-1 (TYCO)	Shielded L=11cm	G/P

4. User Manual

Printed User Manual	G/M
---------------------	-----

How to order G5kW - Power Supply Identification / Accessories

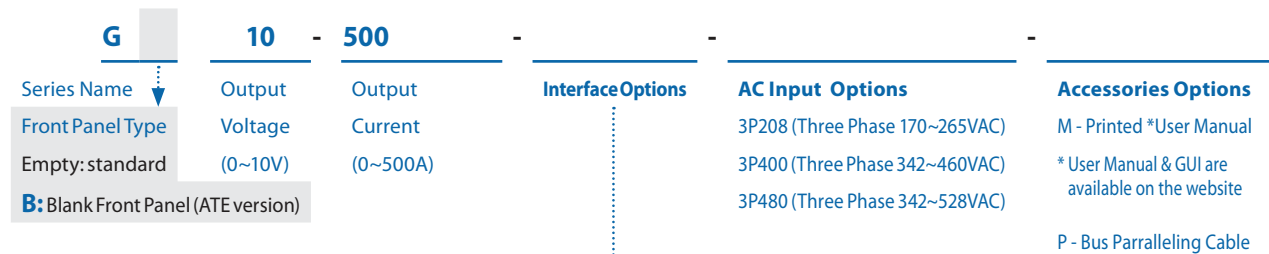

Interface Options (Factory installed)

Interface Options	P/N
LAN (1.5 compliant with Multi-Drop capability)- built-in	-
USB 2.0 compliant with Multi-Drop capability - built-in	-
RS-232/RS-485 - built-in	-
Isolated Analog Program/Monitor Interface (5V/10V Pgm/Mon with 600V isolation) - built-in	-
IEEE (488.2 & SCPI compliant with Multi-Drop capability installed)	IEEE
Modbus-TCP	MDBS
EtherCAT	ECAT
Isolated Analog Current Program/Monitor Interface (4mA-20mA with 600V isolation)	IS420

Models 5kW

Model	Voltage (VDC)	Current (A)	Power (W)	Model	Voltage (VDC)	Current (A)	Power (W)
G10-500	0~10V	0~500	5000	G150-34	0~150V	0~34	5100
G20-250	0~20V	0~250	5000	G200-25	0~200V	0~25	5000
G30-170	0~30V	0~170	5100	G300-17	0~300V	0~17	5100
G40-125	0~40V	0~125	5000	G400-13	0~400V	0~13	5200
G50-100	0~50V	0~100	5000	G500-10	0~500V	0~10	5000
G60-85	0~60V	0~85	5100	G600-8.5	0~600V	0~8.5	5100
G80-65	0~80V	0~65	5200	G1000-5	0~1000V	0~5	5000
G100-50	0~100V	0~50	5000	G1500-3.4	0~1500V	0~3.4	5100

Accessories

Accessories will be sent separately from the Power Supply packing, according to order.

1. Serial Communication cable

RS-232/RS-485 cable is used to connect the power supply to the Host PC.

Mode	RS-485	RS-232
PC Connector	DB-9F	DB-9F
Communication Cable	Shielded L=2m	Shielded L=2m
Power Supply Connector	RJ-45	RJ-45
P/N	GEN/485-9	GEN/232-9

2. Serial link cable (Included with the power supply)

Daisy-chain up to 31 GENESYS™ power supplies.

Mode	Power Supply Connector	Communication Cable	P/N
RS-485	RJ-45	Shielded L=50cm	GEN/RJ45

3. Bus Paralleling cable

Connectors	Cables	P/N
2013595-1 (TYCO)	Shielded L=11cm	G/P

4. User Manual

Printed User Manual	P/N
	G/M

5. Parallel Kit: 20kW/30kW

G/P-4U: BusBar Parallel Kit for 20 kW operation (5kW Models where Vout up to 100V)

G/P-6U: BusBar Parallel Kit for 30 kW operation (5kW Models where Vout up to 100V)

How to order G7.5kW - Power Supply Identification / Accessories

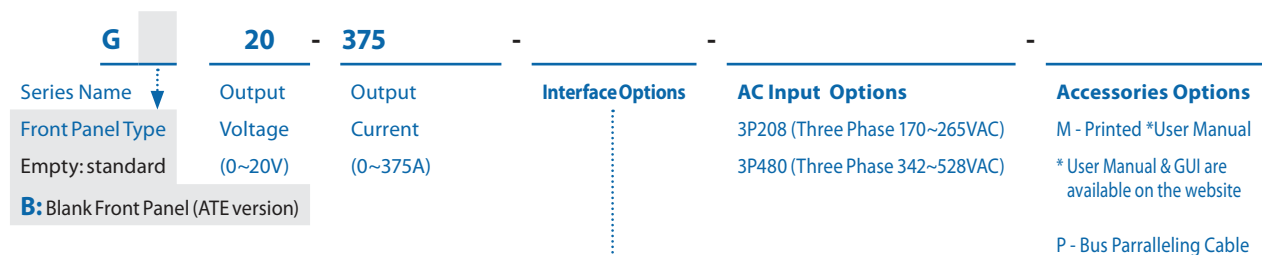

Interface Options (Factory installed)

Interface Options (Factory installed)	P/N
LAN (LV 1.5 compliant with Multi-Drop capability) - built-in	-
USB 2.0 compliant with Multi-Drop capability - built-in	-
RS-232/RS-485 - built-in	-
Isolated Analog Program/Monitor Interface (5V/10V Pgm/Mon with 600V isolation) - built-in	-
IEEE (488.2 & SCPI compliant with Multi-Drop capability installed)	IEEE
Modbus-TCP	MDBS
EtherCAT	ECAT

Models 7.5kW

Model	Voltage (VDC)	Current (A)	Power (W)	Model	Voltage (VDC)	Current (A)	Power (W)
G20-375	0~20V	0~375	7500	G150-50	0~150V	0~50	7500
G30-250	0~30V	0~250	7500	G200-37.5	0~200V	0~37.5	7500
G40-188	0~40V	0~188	7520	G300-25	0~300V	0~25	7500
G60-125	0~60V	0~125	7500	G600-12.5	0~600V	0~12.5	7500
G80-94	0~80V	0~94	7500	G1000-7.5	0~1000V	0~7.5	7500
G100-75	0~100V	0~75	7500	G1500-5	0~1500V	0~5	7500

Accessories

Accessories will be sent separately from the Power Supply packing, according to order.

1. Serial Communication cable

RS-232/RS-485 cable is used to connect the power supply to the Host PC.

Mode	RS-485	RS-232
PC Connector	DB-9F	DB-9F
Communication Cable	Shielded L=2m	Shielded L=2m
Power Supply Connector	RJ-45	RJ-45
P/N	GEN/485-9	GEN/232-9

2. Serial link cable (Included with the power supply)

Daisy-chain up to 31 GENESYS™ power supplies.

Mode	Power Supply Connector	Communication Cable	P/N
RS-485	RJ-45	Shielded L=50cm	GEN/RJ45

3. Bus Parralleling cable

Connectors	Cables	P/N
2013595-1 (TYCO)	Shielded L=11cm	G/P

4. User Manual

Printed User Manual	P/N
	G/M

5. Parallel Kit: 30kW/45kW

G/P-4U: BusBar Parallel Kit for 30 kW operation

G/P-6U: BusBar Parallel Kit for 45 kW operation

How to order GSP10kW-15kW - Power Supply Identification / Accessories

G	SP	10	-	1500	-	-	-
Series Name	Output	Output	Interface Options		AC Input Options	Accessories Options	
Front Panel Type	Voltage	Current	P/N		3P208 (Three Phase 170~265VAC)	M - Printed *User Manual	
Empty: standard	(0~10V)	(0~1500A)			3P400 (Three Phase 342~460VAC)	* User Manual & GUI are available on the website	
B: Blank Front Panel (ATE version)					3P480 (Three Phase 342~528VAC)		

Interface Options (Factory installed)

LAN (LAN 1.5 compliant with Multi-Drop capability)- built-in	-
USB 2.0 compliant with Multi-Drop capability - built-in	-
RS-232/RS-485 - built-in	-
Isolated Analog Program/Monitor Interface (5V/10V Pgm/Mon with 600V isolation) - built-in	-
IEEE (488.2 & SCPI compliant with Multi-Drop capability installed)	IEEE
Modbus-TCP	MDBS
EtherCAT	ECAT
Isolated Analog Current Program/Monitor Interface (4mA-20mA with 600V isolation)	IS420

Models GSP 10kW

Model	Voltage (VDC)	Current (A)	Power (kW)	Model	Voltage (VDC)	Current (A)	Power (kW)
GSP10-1000	0~10V	0~1000	10	GSP100-100	0~100V	0~100	10
GSP20-500	0~20V	0~500	10	GSP150-68	0~150V	0~68	10.2
GSP30-340	0~30V	0~340	10.2	GSP200-50	0~200V	0~50	10
GSP40-250	0~40V	0~250	10	GSP300-34	0~300V	0~34	10.2
GSP50-200	0~50V	0~200	10	GSP400-26	0~400V	0~26	10.4
GSP60-170	0~60V	0~170	10.2	GSP500-20	0~500V	0~20	10
GSP80-130	0~80V	0~130	10.4	GSP600-17	0~600V	0~17	10.2

Models GSP 15kW

Model	Voltage (VDC)	Current (A)	Power (kW)	Model	Voltage (VDC)	Current (A)	Power (kW)
GSP10-1500	0~10V	0~1500	15	GSP100-150	0~100V	0~150	15
GSP20-750	0~20V	0~750	15	GSP150-102	0~150V	0~102	15.3
GSP30-510	0~30V	0~510	15.3	GSP200-75	0~200V	0~75	15
GSP40-375	0~40V	0~375	15	GSP300-51	0~300V	0~51	15.3
GSP50-300	0~50V	0~300	15	GSP400-39	0~400V	0~39	15.6
GSP60-255	0~60V	0~255	15.3	GSP500-30	0~500V	0~30	15
GSP80-195	0~80V	0~195	15.6	GSP600-25.5	0~600V	0~25.5	15.3

Accessories

Accessories will be sent separately from the Power Supply packing, according to order.

1. Serial Communication cable

RS-232/RS-485 cable is used to connect the power supply to the Host PC.

Mode	RS-485	RS-232
PC Connector	DB-9F	DB-9F
Communication Cable	Shielded L=2m	Shielded L=2m
Power Supply Connector	RJ-45	RJ-45
P/N	GEN/485-9	GEN/232-9

2. Bus Paralleling cable (Included with the power supply)

Connectors	Cables	P/N
2013595-1 (TYCO)	Shielded L=11cm	G/P

3. User Manual

Printed User Manual	G/M
---------------------	-----

GENESYS™ Family Output Voltage and Current

Models Series	G (Std Front Panel Display) GB (Blank Front Panel Display)						GSP/GBSP (Scalable Power)		
	1kW	1.7kW	2.7kW	3.4kW	5kW	5kW - HV	7.5kW	10kW	15kW
Rated Power	1kW	1.7kW	2.7kW	3.4kW	5kW	5kW - HV	7.5kW	10kW	15kW
Voltage Range	Current Range (A)								
0-10V	0~100A	0~170A	0~265A	0~340A	0~500A		-	0~1000A	0~1500A
0-20V	0~50A	0~85A	0~135A	0~170A	0~250A		0~375A	0~500A	0~750A
0-30V	0~34A	0~56A	0~90A	0~112A	0~170A		0~250A	0~340A	0~510A
0-40V	0~25A	0~42A	0~68A	0~85A	0~125A		0~188A	0~250A	0~375A
0-50V	-	-	-	-	0~100A		-	0~200A	0~300A
0-60V	0~17A	0~28A	0~45A	0~56A	0~85A		0~125A	0~170A	0~255A
0-80V	0~12.5A	0~21A	0~34A	0~42A	0~65A		0~94A	0~130A	0~195A
0-100V	0~10A	0~17A	0~27A	0~34A	0~50A		0~75A	0~100A	0~150A
0-150V	0~7A	0~11.2A	0~18A	0~22.5A	0~34A		0~50A	0~68A	0~102A
0-200V	-	-	-	-	0~25A		0~37.5A	0~50A	0~75A
0-300V	0~3.5A	0~5.6A	0~9A	0~11.5A	0~17A		0~25A	0~34A	0~51A
0-400V	-	-	-	-	0~13A		-	0~26A	0~39A
0-500V	-	-	-	-	0~10A		-	0~20A	0~30A
0-600V	0~1.7A	0~2.8A	0~4.5A	0~5.6A	0~8.5A		0~12.5A	0~17A	0~25.5A
0-1000V	-	-	-	-		0~0.5A	0~7.5A	-	-
0-1500V	-	-	-	-		0~3.4A	0~5A	-	-
Weight (kg/lb)	5/11	5/11	6.25/14.3	6.25/14.3	7.5/16.5	8.5/18.7	8.5/18.7	15.5/34.2	23.5/51.8

AC Input Range

Rated Power	1kW	1.7kW	2.7kW	3.4kW	5kW	7.5kW	10kW	15kW
1Ø, 85-265Vac	*	*	N/A	N/A	N/A	N/A	N/A	N/A
1Ø, 170-265Vac			*	*	N/A	N/A	N/A	N/A
3P208	N/A	N/A	*	*	*	*	*	*
3P400	N/A	N/A	*	*	*	N/A	*	*
3P480	N/A	N/A	*	*	*	*	*	*

3P208 (Three Phase 170~265VAC), 3P400 (Three Phase 342~460VAC), 3P480 (Three Phase 342~528VAC)

**Also available GH 1kW/1.5kW Series
Half-Rack 1kW/1.5kW in 1U Height**



Models 1kW

Model	Voltage (V)	Current (A)	Power (W)
GH10-100	0~10V	0~100	1000
GH20-50	0~20V	0~50	1000
GH30-34	0~30V	0~34	1020
GH40-25	0~40V	0~25	1000
GH60-17	0~60V	0~17	1020

Model	Voltage (V)	Current (A)	Power (W)
GH80-12.5	0~80V	0~12.5	1000
GH100-10	0~100V	0~10	1000
GH150-7	0~150V	0~7	1050
GH300-3.5	0~300V	0~3.5	1050
GH600-1.7	0~600V	0~1.7	1020

Models 1.5kW

Model	Voltage (V)	Current (A)	Power (W)
GH10-150	0~10V	0~150	1500
GH20-75	0~20V	0~75	1500
GH30-50	0~30V	0~50	1500
GH40-38	0~40V	0~38	1520
GH60-25	0~60V	0~25	1500

Model	Voltage (V)	Current (A)	Power (W)
GH80-19	0~80V	0~19	1520
GH100-15	0~100V	0~15	1500
GH150-10	0~150V	0~10	1500
GH300-5	0~300V	0~5	1500
GH600-2.6	0~600V	0~2.6	1560

GENESYS™ 1kW SERIES SPECIFICATIONS

OUTPUT RATING		G	10-100	20-50	30-34	40-25	60-17	80-12.5	100-10	150-7	300-3.5	600-1.7
1. Rated output voltage (*1)	V		10	20	30	40	60	80	100	150	300	600
2. Rated output current (*2)	A		100	50	34	25	17	12.5	10	7	3.5	1.7
3. Rated output power	W		1000	1000	1020	1000	1020	1000	1000	1050	1050	1020
INPUT CHARACTERISTICS		V	10	20	30	40	60	80	100	150	300	600
1. Input voltage/freq. (*3)	---	85~265Vac, continuous, 47~63Hz, Single Phase										
2. Maximum Input current at 100% load (100/200)	A	12.5/6.5										
3. Power Factor (Typ)	---	0.99 @ 100Vac 0.98 @ 200Vac, rated output power.										
4. Efficiency at 100 Vac/200Vac, rated output (*17)	%		86/88	87/89	87/89	87/89	87/89	87/89	88/90	88/90	88/90	88/90
5. Inrush current (*5)	A	Less than 50A										
CONSTANT VOLTAGE MODE		V	10	20	30	40	60	80	100	150	300	600
1. Max. Line regulation (*6)	---	0.01% of rated output voltage										
2. Max. Load regulation (*7)	---	0.01% of rated output voltage +2mV										
3. Ripple and noise (p-p, 20MHz) (*8)	mV		50	50	50	60	60	75	75	75	120	500
4. Ripple r.m.s. 5Hz~1MHz (*8)	mV		6	6	6	7	7	10	12	9	20	100
5. Temperature coefficient	PPM/°C	50PPM/°C from rated output voltage, following 30 minutes warm-up.										
6. Temperature stability	---	0.01% of rated Vout over 8hrs interval following 30 minutes warm-up. Constant line, load & temp.										
7. Warm-up drift	---	Less than 0.01% of rated output voltage+2mV over 30 minutes following power on.										
8. Remote sense compensation/wire (*10)	V		2	2	5	5	5	5	5	5	5	5
9. Up-prog. Response time (*11)	mS		35	35	35	35	35	35	40	50	100	100
10. Down-prog. response time:	Full load (*12)	mS	35	30	60	60	60	60	80	120	220	220
	No load (*12)	mS	500	700	1000	1200	1500	1700	2600	2900	4600	4600
11. Transient response time	mS	Time for output voltage to recover within 0.5% of its rated output for a load change 10~90% of rated output current. Output set-point: 10~100%, Local sense. Less than 1mS, for models up to and including 100V. 2mS, for models above 100V.										
12. Start up delay	Sec	Less than 6 Sec										
13. Hold-up time	mS	20ms typical, rated output power										
CONSTANT CURRENT MODE		V	10	20	30	40	60	80	100	150	300	600
1. Max. Line regulation (*6)	---	0.02% of rated output current. +2mA										
2. Max. Load regulation (*9)	---	0.02% of rated output current. +5mA										
3. Ripple r.m.s. @ rated voltage. B.W 5Hz~1MHz. (*13)	mA		≤420	≤160	≤100	≤60	≤50	≤30	≤20	≤10	≤8	≤5
5. Temperature coefficient	PPM/°C	10V~100V 100PPM/°C from rated output current, following 30 minutes warm-up. 150V~600V 70PPM/°C from rated output current, following 30 minutes warm-up.										
6. Temperature stability	---	0.01% of rated Iout over 8hrs. interval following 30 minutes warm-up. Constant line, load & temperature.										
7. Warm-up drift	---	10V~100V model: Less than +/-0.25% of rated output current over 30 minutes following power on. 150V~600V: Less than +/-0.15% of rated output current over 30 minutes following power on.										
ANALOG PROGRAMMING AND MONITORING (ISOLATED FROM THE OUTPUT)												
1. Vout voltage programming	---	0~100%, 0~5V or 0~10V, user selectable. Accuracy and linearity: +/-0.15% of rated Vout.										
2. Iout voltage programming (*14)	---	0~100%, 0~5V or 0~10V, user selectable. Accuracy and linearity: +/-0.4% of rated Iout.										
3. Vout resistor programming	---	0~100%, 0~5/10Kohm full scale, user selectable. Accuracy and linearity: +/-0.5% of rated Vout.										
4. Iout resistor programming (*14)	---	0~100%, 0~5/10Kohm full scale, user selectable. Accuracy and linearity: +/-0.5% of rated Iout.										
5. Output voltage monitor	---	0~5V or 0~10V, user selectable. Accuracy: +/-0.5% of rated Vout.										
6. Output current monitor (*14)	---	0~5V or 0~10V, user selectable. Accuracy: +/-0.5% of rated Iout.										
SIGNALS AND CONTROLS (ISOLATED FROM THE OUTPUT)												
1. Power supply OK #1 signal	---	Power supply output monitor. Open collector. Output On: On. Output Off: Off. Maximum Voltage: 30V, Maximum Sink Current: 10mA.										
2. CV/CC signal	---	CV/CC Monitor. Open collector. CC mode: On. CV mode: Off. Maximum Voltage: 30V, Maximum Sink Current: 10mA.										
3. LOCAL/REMOTE Analog control	---	Enable/Disable analog programming control by electrical signal or dry contact. Remote: 0~0.6V or short. Local: 2~30V or open.										
4. LOCAL/REMOTE Analog signal	---	analog programming control monitor signal. Open collector. Remote: On. Local: Off. Maximum Voltage: 30V, Maximum Sink Current: 10mA.										
5. ENABLE/DISABLE signal	---	Enable/Disable PS output by electrical signal or dry contact. 0~0.6V or short, 2~30V or open. User selectable logic.										
6. INTERLOCK (ILC) control	---	Enable/Disable PS output by electrical signal or dry contact. Remote: 0~0.6V or short. Local: 2~30V or open.										
7. Programmed signals	---	Two open drain programmable signals. Maximum voltage 25V, Maximum sink current 100mA (Shunted by 27V zener)										
8. TRIGGER IN / TRIGGER OUT signals	---	Maximum low level input voltage = 0.8V, Minimum high level input voltage = 2.5V, Maximum high level input = 5V positive edge trigger: tw=10us minimum. Tr, Tf=1us Maximum, Min delay between 2 pulses 1ms.										
9. DAISY_IN/SO control signal	---	By electrical Voltage: 0~0.6V/2~30V or dry contact.										
10. DAISY_OUT/PS_OK #2 signal	---	4~5V=OK, 0V (500ohm impedance)=Fail										
FUNCTIONS AND FEATURES												
1. Parallel operation	---	Possible. Up to 4 identical units in Master/Slave mode. Refer to instruction manual.										
2. Series operation	---	Possible. Two identical units. Refer to instruction manual.										
3. Daisy chain	---	Power supplies can be connected in Daisy chain to synchronize their turn-on and turn-off.										
4. Constant power control	---	Limits the output power to a programmed value. Programming via the communication ports or the front panel.										
5. Output resistance control	---	Emulates series resistance. Resistance range: 1~1000mΩ. Programming via the communication ports or the front panel.										
6. Slew rate control	---	Programmable Output rise and Output fall slew rate. Programming range: 0.0001~999.99 V/mSec. or A/mSec. Programming via the communication ports or the front panel.										
7. Arbitrary waveforms	---	Profiles of up to 100 steps can be stored in 4 memory cells. Activation by command via the communication ports or by the front panel.										
PROGRAMMING AND READBACK (USB, LAN, RS232/485, Optional IEEE (*16) Interfaces)		V	10	20	30	40	60	80	100	150	300	600
1. Vout programming accuracy (*15)	---	0.05% of rated output voltage										
2. Iout programming accuracy (*14)	---	0.1% of actual output current+0.2% of rated output current										
3. Vout programming resolution	---	0.002% of rated output voltage										
4. Iout programming resolution	---	0.002% of rated output current										
5. Vout readback accuracy	---	0.05% of rated output voltage										
6. Iout readback accuracy (*14)	---	0.2% of rated output current										
7. Vout readback resolution (of rated output voltage)	%		0.011%	0.006%	0.004%	0.003%	0.002%	0.002%	0.011%	0.007%	0.004%	0.002%
8. Iout readback resolution (of rated output current)	%		0.011%	0.003%	0.004%	0.005%	0.007%	0.009%	0.011%	0.015%	0.004%	0.007%

GENESYS™ 1.7kW SERIES SPECIFICATIONS

OUTPUT RATING		G	10-170	20-85	30-56	40-42	60-28	80-21	100-17	150-11.2	300-5.6	600-2.8
1. Rated output voltage (*1)	V		10	20	30	40	60	80	100	150	300	600
2. Rated output current (*2)	A		170	85	56	42	28	21	17	11.2	5.6	2.8
3. Rated output power	W		1700	1700	1680	1680	1680	1680	1700	1680	1680	1680
INPUT CHARACTERISTICS		V	10	20	30	40	60	80	100	150	300	600
1. Input voltage/freq. (*3)	---	85~265Vac, continuous, 47~63Hz, Single Phase										
2. Maximum Input current at 100% load (100/200)	A	20/10										
3. Power Factor (Typ)	---	0.99 @ 100Vac 0.98 @ 200Vac, rated output power.										
4. Efficiency at 100 Vac/200Vac, rated output (*19)	%	86/88 87/89 87/89 87/89 87/89 87/89 88/90 88/90 88/90 88/90										
5. Inrush current (*5)	A	Less than 50A										
CONSTANT VOLTAGE MODE		V	10	20	30	40	60	80	100	150	300	600
1. Max. Line regulation (*6)	---	0.01% of rated output voltage										
2. Max. Load regulation (*7)	---	0.01% of rated output voltage +2mV										
3. Ripple and noise (p-p, 20MHz) (*8)	mV	50	50	50	60	60	75	75	75	120	500	
4. Ripple r.m.s. 5Hz~1MHz (*8)	mV	6	6	6	7	7	10	12	8	20	100	
5. Temperature coefficient	PPM/°C	50PPM/°C from rated output voltage, following 30 minutes warm-up.										
6. Temperature stability	---	0.01% of rated Vout over 8hrs interval following 30 minutes warm-up. Constant line, load & temp.										
7. Warm-up drift	---	Less than 0.01% of rated output voltage+2mV over 30 minutes following power on.										
8. Remote sense compensation/wire (*10)	V	2	2	5	5	5	5	5	5	5	5	
9. Up-prog. Response time (*11)	mS	20	20	20	20	20	20	25	50	100	100	
10. Down-prog. response time:	Full load (*12)	mS	30	30	60	60	60	60	60	120	220	200
	No load (*12)	mS	450	700	1000	1200	1500	1700	2600	2900	4600	4600
11. Transient response time	mS	Time for output voltage to recover within 0.5% of its rated output for a load change 10~90% of rated output current. Output set-point: 10~100%, Local sense. Less than 1mS, for models up to and including 100V. 2mS, for models above 100V.										
12. Start up delay	Sec	Less than 6 Sec										
13. Hold-up time	mS	16ms typical, rated output power										
CONSTANT CURRENT MODE		V	10	20	30	40	60	80	100	150	300	600
1. Max. Line regulation (*6)	---	0.01% of rated output current. +2mA										
2. Max. Load regulation (*9)	---	0.02% of rated output current. +5mA										
3. Ripple r.m.s. @ rated voltage. B.W 5Hz~1MHz. (*13)	mA	≤420	≤160	≤100	≤60	≤50	≤30	≤20	≤10	≤8	≤5	
5. Temperature coefficient	PPM/°C	10V~100V 100PPM/°C from rated output current, following 30 minutes warm-up. 150V~600V 70PPM/°C from rated output current, following 30 minutes warm-up.										
6. Temperature stability	---	0.01% of rated Iout over 8hrs. interval following 30 minutes warm-up. Constant line, load & temperature.										
7. Warm-up drift	---	10V~100V model: Less than +/-0.25% of rated output current over 30 minutes following power on. 150V~600V: Less than +/-0.15% of rated output current over 30 minutes following power on.										
ANALOG PROGRAMMING AND MONITORING (ISOLATED FROM THE OUTPUT)												
1. Vout voltage programming	---	0~100%, 0~5V or 0~10V, user selectable. Accuracy and linearity: +/-0.15% of rated Vout.										
2. Iout voltage programming (*14)	---	0~100%, 0~5V or 0~10V, user selectable. Accuracy and linearity: +/-0.4% of rated Iout.										
3. Vout resistor programming	---	0~100%, 0~5/10Kohm full scale, user selectable. Accuracy and linearity: +/-0.5% of rated Vout.										
4. Iout resistor programming (*14)	---	0~100%, 0~5/10Kohm full scale, user selectable. Accuracy and linearity: +/-0.5% of rated Iout.										
5. Output voltage monitor	---	0~5V or 0~10V, user selectable. Accuracy: +/-0.5% of rated Vout..										
6. Output current monitor (*14)	---	0~5V or 0~10V, user selectable. Accuracy: +/-0.5 of rated Iout.%.										
SIGNALS AND CONTROLS (ISOLATED FROM THE OUTPUT)												
1. Power supply OK #1 signal	---	Power supply output monitor. Open collector. Output On: On. Output Off: Off. Maximum Voltage: 30V, Maximum Sink Current: 10mA.										
2. CV/CC signal	---	CV/CC Monitor. Open collector. CC mode: On. CV mode: Off. Maximum Voltage: 30V, Maximum Sink Current: 10mA.										
3. LOCAL/REMOTE Analog control	---	Enable/Disable analog programming control by electrical signal or dry contact. Remote: 0~0.6V or short. Local: 2~30V or open.										
4. LOCAL/REMOTE Analog signal	---	analog programming control monitor signal. Open collector. Remote: On. Local: Off. Maximum Voltage: 30V, Maximum Sink Current: 10mA.										
5. ENABLE/DISABLE signal	---	Enable/Disable PS output by electrical signal or dry contact. 0~0.6V or short, 2~30V or open. User selectable logic.										
6. INTERLOCK (ILC) control	---	Enable/Disable PS output by electrical signal or dry contact. Remote: 0~0.6V or short. Local: 2~30V or open.										
7. Programmed signals	---	Two open drain programmable signals. Maximum voltage 25V, Maximum sink current 100mA (Shunted by 27V zener)										
8. TRIGGER IN / TRIGGER OUT signals	---	Maximum low level input voltage = 0.8V, Minimum high level input voltage = 2.5V, Maximum high level input = 5V positive edge trigger: tw=10us minimum. Tr, Tf= 1us Maximum, Min delay between 2 pulses 1ms.										
9. DAISY_IN/SO control signal	---	By electrical Voltage: 0~0.6V/2~30V or dry contact.										
10. DAISY_OUT/PS_OK #2 signal	---	4~5V=OK, 0V (500ohm impedance)=Fail										
FUNCTIONS AND FEATURES												
1. Parallel operation	---	Possible. Up to 4 identical units in Master/Slave mode. Refer to instruction manual.										
2. Series operation	---	Possible. Two identical units. Refer to instruction manual.										
3. Daisy chain	---	Power supplies can be connected in Daisy chain to synchronize their turn-on and turn-off.										
4. Constant power control	---	Limits the output power to a programmed value. Programming via the communication ports or the front panel.										
5. Output resistance control	---	Emulates series resistance. Resistance range: 1~1000mΩ. Programming via the communication ports or the front panel.										
6. Slew rate control	---	Programmable Output rise and Output fall slew rate. Programming range: 0.0001~999.99 V/mSec. or A/mSec. Programming via the communication ports or the front panel.										
7. Arbitrary waveforms	---	Profiles of up to 100 steps can be stored in 4 memory cells. Activation by command via the communication ports or by the front panel.										
PROGRAMMING AND READBACK (USB, LAN, RS232/485, Optional IEEE (*18) Interfaces)		V	10	20	30	40	60	80	100	150	300	600
1. Vout programming accuracy (*15)	---	0.05% of rated output voltage										
2. Iout programming accuracy (*14)	---	0.1% of actual output current+0.2% of rated output current										
3. Vout programming resolution	---	0.002% of rated output voltage										
4. Iout programming resolution	---	0.002% of rated output current										
5. Vout readback accuracy	---	0.05% of rated output voltage										
6. Iout readback accuracy (*14)	---	0.2% of rated output current										
7. Vout readback resolution (of rated output voltage)	%	0.011%	0.006%	0.004%	0.003%	0.002%	0.002%	0.011%	0.007%	0.004%	0.002%	
8. Iout readback resolution (of rated output current)	%	0.007%	0.002%	0.003%	0.003%	0.005%	0.006%	0.007%	0.010%	0.003%	0.004%	

GENESYS™ 1kW/1.7kW SERIES SPECIFICATIONS

PROTECTIVE FUNCTIONS	V	10	20	30	40	60	80	100	150	300	600	
1.Foldback protection	---	Output shut-down when power supply changes mode from CV or Power Limit to CC mode or from CC or Power Limit to CV mode. User presetable. Reset by AC input recycle in autostart mode, by Power Switch, by OUTPUT button, by rear panel or by communication.										
2.Over-voltage protection (OVP)	---	Output shut-down. Reset by AC input recycle in autostart mode, by OUTPUT button, by rear panel or by communication.										
3.Over-voltage programming range	V	0.5~12	1~24	2~36	2~44.1	5~66.15	5~88.2	5~110.25	5~165.37	5~330.75	5~661.5	
4.Over-voltage programming accuracy	---	+/-1% of rated output voltage										
5.Output under voltage limit (UVL)	---	Prevents from adjusting Vout below limit. Does not apply in analog programming. Preset by front panel or communication port.										
6.Over temperature protection	---	Shuts down the output. Auto recovery by autostart mode.										
7. Output under voltage limit (UVL)	---	Prevents adjustment of Vout below limit.										
8. Output under voltage protection (UVP)	---	Prevents adjustment of Vout below limit. P.5 output turns Off during under voltage condition. Reset by AC input recycle in autostart mode, by Power Switch, by OUTPUT button, by rear panel or by communication.										

FRONT PANEL		
1.Control functions	---	Multiple options with 2 Encoders
	---	Vout/Iout/Power Limit manual adjust
	---	OVP/UVL/UVP manual adjust
	---	Protection Functions - OVP, UVL,UVP, Foldback, OCL, ENA, ILC
	---	Communication Functions - Selection of LAN,IEEE.RS232,RS485,USB or Optional communication interface.
	---	Output ON/OFF, Front Panel Lock.
	---	Communication Functions - Selection of Baud Rate, Address, IP and communication language.
	---	Analog Control Functions - Selection Voltage/resistive programming, 5V/10V, 5K/10K programming
	---	Analog Monitor Functions - Selection of Voltage/Current Monitoring 5V/10V.
2.Display	---	Vout: 4 digits, accuracy: 0.05% of rated output voltage +/-1 count.
	---	Iout: 4 digits, accuracy: 0.2% of rated output current +/-1 count.
3.Front Panel Buttons Indications	---	OUTPUT ON, ALARM, PREVIEW, FINE, COMMUNICATION, PROTECTION,CONFIGURATION, SYSTEM, SEQUENCER.
4. Front Panel Display Indications	---	Voltage, Current, Power, CV, CC, CP, External Voltage, External Current, Address, LFP, Autostart, Safetstart, Foldback V/I, Remote (communication), RS/USB/LAN/IEEE communication, Trigger, Load/Store Cell.

ENVIRONMENTAL CONDITIONS		
1.Operating temperature	---	0~50°C, 100% load.
2.Storage temperature	---	-30~85°C
3.Operating humidity	%	20~90% RH (no condensation).
4.Storage humidity	%	10~95% RH (no condensation).
5.Altitude	---	Operating: 10000ft (3000m), output current derating 2%/100m or Ta derating 1°C/100m above 2000m. Non operating: 40000ft (12000m).

MECHANICAL		
1.Cooling	---	Forced air cooling by internal fans. Air flow direction: from Front panel to power supply rear
2.Weight	kg	Less than 5kg.
3.Dimensions (WxHxD)	mm	W: 423, H: 43.6, D: 441.5 (Without busbars and busbars cover), W: 423, H: 43.6, D: 553.2 (Including busbars and busbars cover) (Refer to Outline drawing).
4.Vibration	---	MIL-810G, method 514.6, Procedure I, test condition Annex C - 2.1.3.1
5.Shock	---	Less than 20G, half sine, 11mSec. Unit is unpacked.

SAFETY/EMC			
1.Applicable standards:	Safety G1kW/G1.7kW	---	UL61010-1, CSA22.2 No.61010-1, IEC61010-1, EN61010-1.
1.1. Interface classification	G1kW/1.7kW	---	Vouts<50V Models: Output, J1, J2, J3, J4, J5, J6, J7, J8 (sense) & J9 (communication options) are Non Hazardous. 60s<Vouts<600V Models: Output & J8 (sense) are hazardous, J1, J2, J3, J4, J5, J6, J7 & J9 (communication options) are Non Hazardous.
1.2 Withstand voltage	G1kW/1.7kW	---	Vouts<50V Models: Input – Output & J8 (sense), J1, J2, J3, J4, J5, J6, J7 & J9 (communication options): 4242VDC 1min, Input - Ground: 2835VDC 1min. 60V<Vouts<100V Models: Input – Output & J8 (sense), J1, J2, J3, J4, J5, J6, J7 & J9 (communication options): 4242VDC 1min, Output & J8 (sense) - J1, J2, J3, J4, J5, J6, J7 & J9 (communication options): 850VDC 1min. Output & J8 (sense) - Ground: 1500VDC 1min, Input - Ground: 2835VDC 1min. 100V<Vouts<600V Models: Input – Output & J8 (sense), J1, J2, J3, J4, J5, J6, J7 and J9 (communication options): 4242VDC 1min. Output & J8 (sense) - J1, J2, J3, J4, J5, J6, J7 & J9 (communication options): 1275VDC 1min. Output & J8 (sense) - Ground: 2500VDC 1min. Input - Ground: 2835VDC 1min.
1.3 Insulation resistance		---	100Mohm at 25°C, 70%RH. Output to Ground 500VDC
2.Conducted emission		---	IEC/EN61204-3 Industrial environment, Annex H table H.1, FCC Part 15-A, VCCI-A.
3.Radiated emission		---	IEC/EN61204-3 Industrial environment, Annex H table H.3 and H4, FCC Part 15-A, VCCI-A
4. EMC compliance	EMC (*4)	---	According to IEC/EN61204-3 Industrial environment

Unless otherwise noted, specifications are warranted over the ambient temperature range of 0° to 50°C

NOTES:

- *1: Minimum voltage is guaranteed to maximum 0.1% of rated output voltage.
- *2: Minimum current is guaranteed to maximum 0.2% of rated output current.
- *3: For cases where conformance to various safety standards (UL, IEC, etc...) is required, to be described as 100-240Vac (50/60Hz).
- *4: Signal and control ports interface cables length: Less than 3m, DC output power port cables length: Less than 30m.
- *5: Not including EMI filter inrush current, less than 0.2mSec.
- *6: 85~132Vac or 170~265Vac. Constant load.
- *7: From No-Load to Full-Load, constant input voltage. Measured at the sensing point in Remote Sense.
- *8: For 10V~150V models: Measured with JEITA RC-9131C (1:1) probe. For 200~600V models: Measured with 100:1 probe.
- *9: For load voltage change, equal to the unit voltage rating, constant input voltage.
- *10: The maximum voltage on the power supply terminals must not exceed the rated voltage.
- *11: From 10% to 90% of Rated Output Voltage, with rated, resistive load.
- *12: From 90% to 10% of Rated Output Voltage.
- *13: For 10V model, the ripple is measured at 20~100% of rated output voltage and rated output current. For other models, the ripple is measured at 10~100% of rated output voltage and rated output current. B.W 5Hz~1MHz.
- *14: The Constant Current programming, readback and monitoring accuracy do not include the warm-up and Load regulation thermal drift.
- *15: Measured at the sensing point.
- *16 Max. ambient temperature for using IEEE is 40°C.
- *17: Ta=25°C, rated output power.

GENESYS™ 2.7kW SERIES SPECIFICATIONS

OUTPUT RATING		G	10-265	20-135	30-90	40-68	60-45	80-34	100-27	150-18	300-9	600-4.5	
1. Rated output voltage (*1)	V		10	20	30	40	60	80	100	150	300	600	
2. Rated output current (*2)	A		265	135	90	68	45	34	27	18	9	4.5	
3. Rated output power	W		2650	2700	2700	2720	2700	2720	2700	2700	2700	2700	
INPUT CHARACTERISTICS		V	10	20	30	40	60	80	100	150	300	600	
1. Input voltage/freq. 3 phase, 3 wire + Ground (*4)	---	3-Phase, 200V models: 170~265Vac, 47~63Hz (Covers 200/230Vac) 3-Phase, 400V models: 342~460Vac, 47~63Hz (Covers 380/400/415Vac) 3-Phase, 480V models: 342~528Vac, 47~63Hz (Covers 380/400/415/440/460/480Vac) 1-Phase, 200V models: 170~265Vac, 47~63Hz (Covers 200/208/230/240Vac)											
2. Maximum Input current at 100% load	3-Phase, 200V models: 3-Phase, 400V models: 3-Phase, 480V models: 1-Phase, 200V models:	---	10A @ 200Vac 5.5A @ 380Vac 5.5A @ 380Vac 16.5A @ 200Vac										
3. Power Factor (Typ)		---	For 3-Phase: 0.94 @ 200/380Vac, rated output power. For 1-Phase: 0.99 @ 200Vac, rated output power.										
4. Efficiency (Typ) (*5) (*22)	%		88	89	89.5	90	90	90.5	90.5	90.5	90.5	90.5	
5. Inrush current (*6)	A		Less than 50A										
CONSTANT VOLTAGE MODE		V	10	20	30	40	60	80	100	150	300	600	
1. Max. Line regulation (*7)	---		0.01% of rated output voltage										
2. Max. Load regulation (*8)	---		0.01% of rated output voltage +5mV										
3. Ripple and noise (p-p, 20MHz) (*9)	mV		75	75	75	75	80	80	100	120	200	480	
4. Ripple r.m.s. 5Hz~1MHz (*9)	mV		8	10	10	12	15	15	15	20	60	100	
5. Temperature coefficient	PPM/°C		50PPM/°C from rated output voltage, following 30 minutes warm-up.										
6. Temperature stability	---		0.01% of rated Vout over 8hrs interval following 30 minutes warm-up. Constant line, load & temp.										
7. Warm-up drift	---		Less than 0.05% of rated output voltage +2mV over 30 minutes following power on.										
8. Remote sense compensation/wire (*10)	V		2	2	5	5	5	5	5	5	5	5	
9. Up-prog. Response time (*11)	mS		30	30	30	30	50	50	50	50	100	100	
10. Down-prog. response time:	Full load (*11)	mS	50	50	80	80	80	100	100	100	100	200	
	No load (*12)	mS	450	600	800	900	1100	1300	2100	2000	3200	3100	
11. Transient response time	mS		Time for output voltage to recover within 0.5% of its rated output for a load change 10~90% of rated output current. Output set-point: 10~100%, Local sense. Less than 1mS, for models up to and including 100V. 2mS, for models above 100V.										
12. Start up delay	Sec		Less than 6 Sec										
CONSTANT CURRENT MODE		V	10	20	30	40	60	80	100	150	300	600	
1. Max. Line regulation (*7)	---		0.05% of rated output current.										
2. Max. Load regulation (*13)	---		0.08% of rated output current.										
3. Ripple r.m.s. @ rated voltage. 3-Phase (*14)	mA		≤800	≤450	≤300	≤150	≤100	≤70	≤45	≤30	≤12	≤5	
4. Ripple r.m.s. @ rated voltage. 1-Phase (*14)	mA		≤1200	≤600	≤300	≤300	≤200	≤100	≤60	≤40	≤12	≤8	
5. Temperature coefficient	PPM/°C		10V~100V 100PPM/°C from rated output current, following 30 minutes warm-up. 150V~600V 70PPM/°C from rated output current, following 30 minutes warm-up.										
6. Temperature stability	---		0.01% of rated Iout over 8hrs. interval following 30 minutes warm-up. Constant line, load & temperature.										
7. Warm-up drift	---		10V~100V model: Less than +/-0.25% of rated output current over 30 minutes following power on. 150V~600V: Less than +/-0.15% of rated output current over 30 minutes following power on.										
ANALOG PROGRAMMING AND MONITORING (ISOLATED FROM THE OUTPUT)													
1. Vout voltage programming	---		0~100%, 0~5V or 0~10V, user selectable. Accuracy and linearity: +/-0.15% of rated Vout.										
2. Iout voltage programming (*15)	---		0~100%, 0~5V or 0~10V, user selectable. Accuracy and linearity: +/-0.4% of rated Iout.										
3. Vout resistor programming	---		0~100%, 0~5/10Kohm full scale, user selectable. Accuracy and linearity: +/-0.5% of rated Vout.										
4. Iout resistor programming (*15)	---		0~100%, 0~5/10Kohm full scale, user selectable. Accuracy and linearity: +/-0.5% of rated Iout.										
5. Output voltage monitor	---		0~5V or 0~10V, user selectable. Accuracy: +/-0.5%.										
6. Output current monitor (*15)	---		0~5V or 0~10V, user selectable. Accuracy: +/-0.5%.										
SIGNALS AND CONTROLS (ISOLATED FROM THE OUTPUT)													
1. Power supply OK #1 signal	---		Power supply output monitor. Open collector. Output On: On. Output Off: Off. Maximum Voltage: 30V, Maximum Sink Current: 10mA.										
2. CV/CC signal	---		CV/CC Monitor. Open collector. CC mode: On. CV mode: Off. Maximum Voltage: 30V, Maximum Sink Current: 10mA.										
3. LOCAL/REMOTE Analog control	---		Enable/Disable analog programming control by electrical signal or dry contact. Remote: 0~0.6V or short. Local: 2~30V or open.										
4. LOCAL/REMOTE Analog signal	---		analog programming control monitor signal. Open collector. Remote: On. Local: Off. Maximum Voltage: 30V, Maximum Sink Current: 10mA.										
5. ENABLE/DISABLE signal	---		Enable/Disable PS output by electrical signal or dry contact. 0~0.6V or short, 2~30V or open. User selectable logic.										
6. INTERLOCK (ILC) control	---		Enable/Disable PS output by electrical signal or dry contact. Remote: 0~0.6V or short. Local: 2~30V or open.										
7. Programmed signals	---		Two open drain programmable signals. Maximum voltage 25V, Maximum sink current 100mA (Shunted by 27V zener)										
8. TRIGGER IN / TRIGGER OUT signals	---		Maximum low level input voltage = 0.8V, Minimum high level input voltage = 2.5V, Maximum high level input = 5V positive edge trigger: tw=10us minimum. Tr, Tf=1us Maximum, Min delay between 2 pulses 1ms.										
9. DAISY_IN/SO control signal	---		By electrical Voltage: 0~0.6V/2~30V or dry contact.										
10. DAISY_OUT/PS_OK #2 signal	---		4~5V=OK, 0V (500ohm impedance)=Fail										
FUNCTIONS AND FEATURES													
1. Parallel operation	---		Possible. Up to 4 identical units in Master/Slave mode. Refer to instruction manual.										
2. Series operation	---		Possible. Two identical units. Refer to instruction manual.										
3. Daisy chain	---		Power supplies can be connected in Daisy chain to synchronize their turn-on and turn-off.										
4. Constant power control	---		Limits the output power to a programmed value. Programming via the communication ports or the front panel.										
5. Output resistance control	---		Emulates series resistance. Resistance range: 1~1000mΩ. Programming via the communication ports or the front panel.										
6. Slew rate control	---		Programmable Output rise and Output fall slew rate. Programming range: 0.0001~999.99 V/mSec. or A/mSec. Programming via the communication ports or the front panel.										
7. Arbitrary waveforms	---		Profiles of up to 100 steps can be stored in 4 memory cells. Activation by command via the communication ports or by the front panel.										
PROGRAMMING AND READBACK (USB, LAN, RS232/485, Optional IEEE(*19)(*20) Interfaces)		V	10	20	30	40	60	80	100	150	300	600	
1. Vout programming accuracy (*16)	---		0.05% of rated output voltage										
2. Iout programming accuracy (*15)	---		0.1% of actual output current + 0.2% of rated output current										
3. Vout programming resolution	---		0.002% of rated output voltage										
4. Iout programming resolution	---		0.002% of rated output current										
5. Vout readback accuracy	---		0.05% of rated output voltage										
6. Iout readback accuracy (*15)	---		0.2% of rated output current										
7. Vout readback resolution (of rated output voltage)	%		0.011%	0.006%	0.004%	0.003%	0.002%	0.002%	0.011%	0.007%	0.004%	0.002%	
8. Iout readback resolution (of rated output current)	%		0.005%	0.008%	0.002%	0.002%	0.003%	0.004%	0.005%	0.007%	0.002%	0.003%	

GENESYS™ 3.4kW SERIES SPECIFICATIONS

OUTPUT RATING		V	10	20	30	40	60	80	100	150	300	600
1.Rated output voltage(*1)		V	10	20	30	40	60	80	100	150	300	600
2.Rated output current (*2)		A	340 (*3)	170	112	85	56	42	34	22.5	11.5	5.6
3.Rated output power		W	3400	3400	3360	3400	3360	3360	3400	3375	3450	3360
INPUT CHARACTERISTICS		V	10	20	30	40	60	80	100	150	300	600
1.Input voltage/freq. 3 phase, 3 wire + Ground (*4)		---	3-Phase, 200V models: 170~265Vac, 47~63Hz (Covers 200/230Vac) 3-Phase, 400V models: 342~460Vac, 47~63Hz (Covers 380/400/415Vac) 3-Phase, 480V models: 342~528Vac, 47~63Hz (Covers 380/400/415/440/460/480Vac) 1-Phase, 200V models: 170~265Vac, 47~63Hz (Covers 200/208/230/240Vac)									
2. Maximum Input current at 100% load		3-Phase, 200V models: 3-Phase, 400V models: 3-Phase, 480V models: 1-Phase, 200V models:	12.5A @ 200Vac 6.5A @ 380Vac 6.5A @ 380Vac 21A @ 200Vac									
3.Power Factor (Typ)		---	For 3-Phase: 0.94 @ 200/380Vac, rated output power. For 1-Phase: 0.99 @ 200Vac, rated output power.									
4.Efficiency (Typ) (*5) (*22)		%	88	89	89.5	90	90	90.5	90.5	90.5	90.5	90.5
5.Inrush current (*6)		A	Less than 50A									
CONSTANT VOLTAGE MODE		V	10	20	30	40	60	80	100	150	300	600
1.Max. Line regulation (*7)		---	0.01% of rated output voltage									
2.Max. Load regulation (*8)		---	0.01% of rated output voltage +5mV									
3.Ripple and noise (p-p, 20MHz) (*9)		mV	75	75	75	75	80	80	100	120	200	480
4.Ripple r.m.s. 5Hz~1MHz (*9)		mV	8	10	10	12	15	15	15	20	60	100
5.Temperature coefficient		PPM/°C	50PPM/°C from rated output voltage, following 30 minutes warm-up.									
6.Temperature stability		---	0.01% of rated Vout over 8hrs interval following 30 minutes warm-up. Constant line, load & temp.									
7. Warm-up drift		---	Less than 0.05% of rated output voltage+2mV over 30 minutes following power on.									
8.Remote sense compensation/wire (*10)		V	2	2	5	5	5	5	5	5	5	5
9.Up-prog. Response time (*11)		mS	30	30	30	30	50	50	50	50	50	100
10.Down-prog.response time:		Full load (*11)	mS	50	50	80	80	80	100	100	100	200
		No load (*12)	mS	450	600	800	900	1100	1300	2100	2000	3000
11.Transient response time		mS	Time for output voltage to recover within 0.5% of its rated output for a load change 10~90% of rated output current. Output set-point: 10~100%, Local sense. Less than 1mS, for models up to and including 100V. 2mS, for models above 100V.									
12.Start up delay		Sec	Less than 6 Sec									
CONSTANT CURRENT MODE		V	10	20	30	40	60	80	100	150	300	600
1.Max. Line regulation (*7)		---	0.05% of rated output current.									
2.Max. Load regulation (*13)		---	0.08% of rated output current.									
3.Ripple r.m.s. @ rated voltage. 3-Phase (*14)		mA	≤800	≤450	≤300	≤150	≤100	≤70	≤45	≤30	≤12	≤5
4.Ripple r.m.s. @ rated voltage. 1-Phase (*14)		mA	≤1200	≤600	≤300	≤300	≤200	≤100	≤60	≤40	≤12	≤8
5.Temperature coefficient		PPM/°C	10V~100V 100PPM/°C from rated output current, following 30 minutes warm-up. 150V~600V 70PPM/°C from rated output current, following 30 minutes warm-up.									
6.Temperature stability		---	0.01% of rated Iout over 8hrs. interval following 30 minutes warm-up. Constant line, load & temperature.									
7. Warm-up drift		---	10V~100V model: Less than +/-0.25% of rated output current over 30 minutes following power on. 150V~600V: Less than +/-0.15% of rated output current over 30 minutes following power on.									
ANALOG PROGRAMMING AND MONITORING (ISOLATED FROM THE OUTPUT)		---										
1.Vout voltage programming		---	0~100%, 0~5V or 0~10V, user selectable. Accuracy and linearity: +/-0.15% of rated Vout.									
2.Iout voltage programming (*15)		---	0~100%, 0~5V or 0~10V, user selectable. Accuracy and linearity: +/-0.4% of rated Iout.									
3.Vout resistor programming		---	0~100%, 0~5/10Kohm full scale, user selectable. Accuracy and linearity: +/-0.5% of rated Vout.									
4.Iout resistor programming (*15)		---	0~100%, 0~5/10Kohm full scale, user selectable. Accuracy and linearity: +/-0.5% of rated Iout.									
5.Output voltage monitor		---	0~5V or 0~10V, user selectable. Accuracy: +/-0.5%.									
6.Output current monitor (*15)		---	0~5V or 0~10V, user selectable. Accuracy: +/-0.5%.									
SIGNALS AND CONTROLS (ISOLATED FROM THE OUTPUT)		---										
1. Power supply OK #1 signal		---	Power supply output monitor. Open collector. Output On: On. Output Off: Off. Maximum Voltage: 30V, Maximum Sink Current: 10mA.									
2. CV/CC signal		---	CV/CC Monitor. Open collector. CC mode: On. CV mode: Off. Maximum Voltage: 30V, Maximum Sink Current: 10mA.									
3. LOCAL/REMOTE Analog control		---	Enable/Disable analog programming control by electrical signal or dry contact. Remote: 0~0.6V or short. Local: 2~30V or open.									
4. LOCAL/REMOTE Analog signal		---	analog programming control monitor signal. Open collector. Remote: On. Local: Off. Maximum Voltage: 30V, Maximum Sink Current: 10mA.									
5. ENABLE/DISABLE signal		---	Enable/Disable PS output by electrical signal or dry contact. 0~0.6V or short, 2~30V or open. User selectable logic.									
6. INTERLOCK (ILC) control		---	Enable/Disable PS output by electrical signal or dry contact. Remote: 0~0.6V or short. Local: 2~30V or open.									
7. Programmed signals		---	Two open drain programmable signals. Maximum voltage 25V, Maximum sink current 100mA (Shunted by 27V zener)									
8. TRIGGER IN / TRIGGER OUT signals		---	Maximum low level input voltage = 0.8V. Minimum high level input voltage = 2.5V, Maximum high level input = 5V positive edge trigger: tw=10us minimum. Tr,Tf=1us Maximum, Min delay between 2 pulses 1ms.									
9. DAISY_IN/SO control signal		---	By electrical Voltage: 0~0.6V/2~30V or dry contact.									
10. DAISY_OUT/PS_OK #2 signal		---	4~5V=OK, 0V (500ohm impedance)=Fail									
FUNCTIONS AND FEATURES		---										
1. Parallel operation		---	Possible. Up to 4 identical units in Master/Slave mode. Refer to instruction manual.									
2. Series operation		---	Possible. Two identical units. Refer to instruction manual.									
3. Daisy chain		---	Power supplies can be connected in Daisy chain to synchronize their turn-on and turn-off.									
4. Constant power control		---	Limits the output power to a programmed value. Programming via the communication ports or the front panel.									
5. Output resistance control		---	Emulates series resistance. Resistance range: 1~1000mΩ. Programming via the communication ports or the front panel.									
6. Slew rate control		---	Programmable Output rise and Output fall slew rate. Programming range: 0.0001~999.99 V/mSec. or A/mSec. Programming via the communication ports or the front panel.									
7. Arbitrary waveforms		---	Profiles of up to 100 steps can be stored in 4 memory cells. Activation by command via the communication ports or by the front panel.									
PROGRAMMING AND READBACK (USB, LAN, RS232/485, Optional IEEE(*19)(*20) Interfaces)		V	10	20	30	40	60	80	100	150	300	600
1.Vout programming accuracy (*16)		---	0.05% of rated output voltage									
2.Iout programming accuracy (*15)		---	0.1% of actual output current+0.2% of rated output current									
3.Vout programming resolution		---	0.002% of rated output voltage									
4.Iout programming resolution		---	0.002% of rated output current									
5.Vout readback accuracy		---	0.05% of rated output voltage									
6.Iout readback accuracy (*15)		---	0.2% of rated output current									
7.Vout readback resolution (of rated output voltage)		%	0.011%	0.006%	0.004%	0.003%	0.002%	0.002%	0.011%	0.007%	0.004%	0.002%
8.Iout readback resolution (of rated output current)		%	0.004%	0.007%	0.010%	0.002%	0.003%	0.004%	0.004%	0.006%	0.010%	0.003%

GENESYS™ 5kW SERIES SPECIFICATIONS

OUTPUT RATING		G	10-500	20-250	30-170	40-125	50-100	60-85	80-65	100-50	150-34	200-25	300-17	400-13	500-10	600-8.5
1. Rated output voltage(*1)		V	10	20	30	40	50	60	80	100	150	200	300	400	500	600
2. Rated output current (*2)		A	500 (*3)	250	170	125	100	85	65	50	34	25	17	13	10	8.5
3. Rated output power		W	5000	5000	5100	5000	5000	5100	5200	5000	5100	5000	5100	5200	5000	5100
INPUT CHARACTERISTICS		V	10	20	30	40	50	60	80	100	150	200	300	400	500	600
1. Input voltage/freq. 3 phase, 3 wire + Ground (*4)		---	3-Phase, 200V models: 170~265Vac, 47~63Hz (Covers 200/230Vac) 3-Phase, 400V models: 342~460Vac, 47~63Hz (Covers 380/400/415Vac) 3-Phase, 480V models: 342~528Vac, 47~63Hz (Covers 380/400/415/440/460/480Vac)													
2. Maximum Input current at 100% load	3-Phase, 200V models:	---	17.5A @ 200Vac													
	3-Phase, 400V models:	---	9.2A @ 380Vac													
	3-Phase, 480V models:	---	9.2A @ 380Vac													
3. Power Factor (Typ)		---	0.94 @ 200/380Vac, rated output power.													
4. Efficiency (Typ) (*5) (*22)		%	89 (*21)	91	91	91	90	91	91	91	91	91	92	92	92	92
5. Inrush current (*6)		A	Less than 50A													
CONSTANT VOLTAGE MODE		V	10	20	30	40	50	60	80	100	150	200	300	400	500	600
1. Max. Line regulation (*7)		---	0.01% of rated output voltage													
2. Max. Load regulation (*8)		---	0.01% of rated output voltage +5mV													
3. Ripple and noise (p-p, 20MHz) (*9)		mV	75	75	75	75	75	75	80	90	120	200	200	400	450	480
4. Ripple r.m.s. 5Hz~1MHz (*9)		mV	8	10	12	12	12	12	15	15	20	45	60	80	80	100
5. Temperature coefficient		PPM/°C	50PPM/°C from rated output voltage, following 30 minutes warm-up.													
6. Temperature stability		---	0.01% of rated Vout over 8hrs interval following 30 minutes warm-up. Constant line, load & temp.													
7. Warm-up drift		---	Less than 0.05% of rated output voltage+2mV over 30 minutes following power on.													
8. Remote sense compensation/wire (*10)		V	2	2	5	5	5	5	5	5	5	5	5	5	5	5
9. Up-prog. Response time (*11)		mS	30	30	30	30	50	50	50	50	50	50	50	100	100	100
10. Down-prog. response time:	Full load (*11)	mS	50	50	80	80	80	80	100	100	100	100	100	150	200	200
	No load (*12)	mS	300	600	800	900	950	1000	1200	1900	2000	2500	3000	4000	4000	3000
11. Transient response time		mS	Time for output voltage to recover within 0.5% of its rated output for a load change 10~90% of rated output current. Output set-point: 10~100%, Local sense. Less than 1mS, for models up to and including 100V. 2mS, for models above 100V.													
12. Start up delay		Sec	Less than 5 Sec													
CONSTANT CURRENT MODE		V	10	20	30	40	50	60	80	100	150	200	300	400	500	600
1. Max. Line regulation (*7)		---	0.05% of rated output current.													
2. Max. Load regulation (*13)		---	0.08% of rated output current.													
3. Ripple r.m.s. @ rated voltage. B.W 5Hz~1MHz (*14)		mA	≤1200	≤600	≤300	≤150	≤130	≤100	≤70	≤45	≤45	≤45	≤15	≤12	≤10	≤8
5. Temperature coefficient		PPM/°C	10V~100V 100PPM/°C from rated output current, following 30 minutes warm-up. 150V~600V 70PPM/°C from rated output current, following 30 minutes warm-up.													
6. Temperature stability		---	0.01% of rated Iout over 8hrs. interval following 30 minutes warm-up. Constant line, load & temperature.													
7. Warm-up drift		---	10V~100V model: Less than +/-0.25% of rated output current over 30 minutes following power on. 150V~600V: Less than +/-0.15% of rated output current over 30 minutes following power on.													
ANALOG PROGRAMMING AND MONITORING (ISOLATED FROM THE OUTPUT)																
1. Vout voltage programming		---	0~100%, 0~5V or 0~10V, user selectable. Accuracy and linearity: +/-0.15% of rated Vout.													
2. Iout voltage programming (*15)		---	0~100%, 0~5V or 0~10V, user selectable. Accuracy and linearity: +/-0.4% of rated Iout.													
3. Vout resistor programming		---	0~100%, 0~5/10Kohm full scale, user selectable. Accuracy and linearity: +/-0.5% of rated Vout.													
4. Iout resistor programming (*15)		---	0~100%, 0~5/10Kohm full scale, user selectable. Accuracy and linearity: +/-0.5% of rated Iout.													
5. Output voltage monitor		---	0~5V or 0~10V, user selectable. Accuracy: +/-0.5% of rated Vout.													
6. Output current monitor (*15)		---	0~5V or 0~10V, user selectable. Accuracy: +/-0.5% of rated Iout.													
SIGNALS AND CONTROLS (ISOLATED FROM THE OUTPUT)																
1. Power supply OK #1 signal		---	Power supply output monitor. Open collector. Output On: On. Output Off: Off. Maximum Voltage: 30V, Maximum Sink Current: 10mA.													
2. CV/CC signal		---	CV/CC Monitor. Open collector. CC mode: On. CV mode: Off. Maximum Voltage: 30V, Maximum Sink Current: 10mA.													
3. LOCAL/REMOTE Analog control		---	Enable/Disable analog programming control by electrical signal or dry contact. Remote: 0~0.6V or short. Local: 2~30V or open.													
4. LOCAL/REMOTE Analog signal		---	analog programming control monitor signal. Open collector. Remote: On. Local: Off. Maximum Voltage: 30V, Maximum Sink Current: 10mA.													
5. ENABLE/DISABLE signal		---	Enable/Disable PS output by electrical signal or dry contact. 0~0.6V or short, 2~30V or open. User selectable logic.													
6. INTERLOCK (ILC) control		---	Enable/Disable PS output by electrical signal or dry contact. Remote: 0~0.6V or short. Local: 2~30V or open.													
7. Programmed signals		---	Two open drain programmable signals. Maximum voltage 25V, Maximum sink current 100mA (Shunted by 27V zener)													
8. TRIGGER IN / TRIGGER OUT signals		---	Maximum low level input voltage = 0.8V, Minimum high level input voltage = 2.5V, Maximum high level input = 5V positive edge trigger: tw=10us minimum. Tr, Tf=1us Maximum, Min delay between 2 pulses 1ms.													
9. DAISY_IN/SO control signal		---	By electrical Voltage: 0~0.6V/2~30V or dry contact.													
10. DAISY_OUT/PS_OK #2 signal		---	4~5V=OK, 0V (500ohm impedance)=Fail													
FUNCTIONS AND FEATURES																
1. Parallel operation		---	Possible. Up to twelve (12) identical units in Master/Slave mode. Refer to instruction manual. For more power please consult with Factory.													
2. Series operation		---	Possible. Two identical units. Refer to instruction manual.													
3. Daisy chain		---	Power supplies can be connected in Daisy chain to synchronize their turn-on and turn-off.													
4. Constant power control		---	Limits the output power to a programmed value. Programming via the communication ports or the front panel.													
5. Output resistance control		---	Emulates series resistance. Resistance range: 1~1000mΩ. Programming via the communication ports or the front panel.													
6. Slew rate control		---	Programmable Output rise and Output fall slew rate. Programming range: 0.0001~999.99 V/mSec. or A/mSec. Programming via the communication ports or the front panel.													
7. Arbitrary waveforms		---	Profiles of up to 100 steps can be stored in 4 memory cells. Activation by command via the communication ports or by the front panel.													
PROGRAMMING AND READBACK (USB, LAN, RS232/485, Optional IEEE(*19)(*20) Interfaces)		V	10	20	30	40	50	60	80	100	150	200	300	400	500	600
1. Vout programming accuracy (*16)		---	0.05% of rated output voltage													
2. Iout programming accuracy (*15)		---	0.1% of actual output current+0.2% of rated output current													
3. Vout programming resolution		---	0.002% of rated output voltage													
4. Iout programming resolution		---	0.002% of rated output current													
5. Vout readback accuracy		---	0.05% of rated output voltage													
6. Iout readback accuracy (*15)		---	0.2% of rated output current													
7. Vout readback resolution (of rated output voltage)		%	0.011%	0.006%	0.004%	0.003%	0.003%	0.002%	0.002%	0.011%	0.007%	0.005%	0.004%	0.003%	0.003%	0.002%
8. Iout readback resolution (of rated output current)		%	0.003%	0.005%	0.006%	0.009%	0.011%	0.002%	0.002%	0.003%	0.004%	0.004%	0.006%	0.008%	0.011%	0.002%

GENESYS™ 2.7kW/3.4kW/5kW SERIES SPECIFICATIONS

PROTECTIVE FUNCTIONS	V	10	20	30	40	50	60	80	100	150	200	300	400	500	600	
1.Foldback protection	---	Output shut-down when power supply changes mode from CV or Power Limit to CC mode or from CC or Power Limit to CV mode. User presettable. Reset by AC input recycle in autostart mode, by Power Switch, by OUTPUT button, by rear panel or by communication.														
2.Over-voltage protection (OVP)	---	Output shut-down. Reset by AC input recycle in autostart mode, by OUTPUT button, by rear panel or by communication.														
3.Over-voltage programming range	V	0.5-12	1-24	2-36	2-44.1	5-55.125	5-66.15	5-88.2	5-110.25	5-165.37	5-220.5	5-330.75	5-441	5-551.25	5-661.5	
4.Over-voltage programming accuracy	---	+/-1% of rated output voltage														
5.Output under voltage limit (UVL)	---	Prevents from adjusting Vout below limit. Does not apply in analog programming. Preset by front panel or communication port.														
6.Over temperature protection	---	Shuts down the output. Auto recovery by autostart mode.														
7. Output under voltage limit (UVL)	---	Prevents adjustment of Vout below limit.														
8. Output under voltage protection (UVP)	---	Prevents adjustment of Vout below limit. P.S output turns Off during under voltage condition. Reset by AC input recycle in autostart mode, by Power Switch, by OUTPUT button, by rear panel or by communication.														
FRONT PANEL																
1.Control functions	---	Multiple options with 2 Encoders														
	---	Vout/Iout/Power Limit manual adjust														
	---	OVP/UVL/UVP manual adjust														
	---	Protection Functions - OVP, UVL, UVP, Foldback, OCL, ENA, ILC														
	---	Communication Functions - Selection of LAN, IEEE, RS232, RS485, USB or Optional communication interface.														
	---	Output ON/OFF. Front Panel Lock.														
	---	Communication Functions - Selection of Baud Rate, Address, IP and communication language.														
	---	Analog Control Functions - Selection Voltage/resistive programming, 5V/10V, 5K/10K programming														
	---	Analog Monitor Functions - Selection of Voltage/Current Monitoring 5V/10V.														
2.Display	---	Vout: 4 digits, accuracy: 0.05% of rated output voltage +/-1 count.														
	---	Iout: 4 digits, accuracy: 0.2% of rated output current +/-1 count.														
3.Front Panel Buttons Indications	---	OUTPUT ON, ALARM, PREVIEW, FINE, COMMUNICATION, PROTECTION, CONFIGURATION, SYSTEM, SEQUENCER.														
4. Front Panel Display Indications	---	Voltage, Current, Power, CV, CC, CP, External Voltage, External Current, Address, LFP, Autostart, Safetstart, Foldback V/I, Remote (communication), RS/USB/LAN/IEEE communication, Trigger, Load/Store Cell.														
ENVIRONMENTAL CONDITIONS																
1.Operating temperature	---	0~50°C, 100% load.														
2.Storage temperature	---	-30~85°C														
3.Operating humidity	%	20~90% RH (no condensation).														
4.Storage humidity	%	10~95% RH (no condensation).														
5.Altitude (*17)	---	Operating: 10000ft (3000m), output current derating 2%/100m or Ta derating 1°C/100m above 2000m. Non operating: 40000ft (12000m).														
MECHANICAL																
1.Cooling	---	Forced air cooling by internal fans. Air flow direction: from Front panel to power supply rear														
2.Weight	kg	2.7kW/3.4kW - Less than 6.25kg.							5kW - Less than 7.5kg.							
3.Dimensions (WxHxD)	mm	W: 423, H: 43.6, D: 441.5 (Without busbars and busbars cover), W: 423, H: 43.6, D: 553.2 (Including busbars and busbars cover) (Refer to Outline drawing).														
4.Vibration	---	MIL-810G, method 514.6, Procedure I, test condition Annex C - 2.1.3.1														
5.Shock	---	Less than 20G, half sine, 11mSec. Unit is unpacked.														
SAFETY/EMC																
1.Applicable standards:	Safety	---	UL61010-1, CSA22.2 No.61010-1, IEC61010-1, EN61010-1.													
1.1. Interface classification		---	Vouts<50V Models: Output, J1, J2, J3, J4, J5, J6, J7, J8 (sense) & J9 (communication options) are Non Hazardous. 60≤Vouts<600V Models: Output & J8 (sense) are hazardous, J1, J2, J3, J4, J5, J6, J7 & J9 (communication options) are Non Hazardous.													
1.2 Withstand voltage		---	Vouts<50V Models: Input – Output & J8 (sense), J1, J2, J3, J4, J5, J6, J7 & J9 (communication options): 4242VDC 1min, Input - Ground: 2835VDC 1min. 60V≤Vouts<100V Models: Input – Output & J8 (sense), J1, J2, J3, J4, J5, J6, J7 & J9 (communication options): 4242VDC 1min, Output & J8 (sense) - J1, J2, J3, J4, J5, J6, J7 & J9 (communication options): 850VDC 1min. Output & J8 (sense) - Ground: 1500VDC 1min, Input - Ground: 2835VDC 1min. 100V<Vouts<600V Models: Input – Output & J8 (sense), J1, J2, J3, J4, J5, J6, J7 and J9 (communication options): 4242VDC 1min. Output & J8 (sense) - J1, J2, J3, J4, J5, J6, J7 & J9 (communication options): 1275VDC 1min. Output & J8 (sense) - Ground: 2500VDC 1min. Input - Ground: 2835VDC 1min.													
1.3 Insulation resistance		---	100Mohm at 25°C, 70%RH. Output to Ground 500VDC													
2.Conducted emission		---	IEC/EN61204-3 Industrial environment, Annex H table H.1, FCC Part 15-A, VCCI-A.													
3.Radiated emission		---	IEC/EN61204-3 Industrial environment, Annex H table H.3 and H4, FCC Part 15-A, VCCI-A													
4. EMC compliance	EMC(*18)	---	IEC/EN61204-3 Industrial environment													

Unless otherwise noted, specifications are warranted over the ambient temperature range of 0° to 50° C.

NOTES:

- * 1: Minimum voltage is guaranteed to maximum 0.1% of rated output voltage.
- * 2: Minimum current is guaranteed to maximum 0.2% of rated output current.
- * 3: G5KW : Derate 5A/1°C above 40°C G3.4kW : Derate 5A/1°C above 40°C.
- * 4: For cases where conformance to various safety standards (UL, IEC, etc...) is required, to be described as 190-240Vac (50/60Hz) for 3-Phase
- * 5: 3-Phase 200V models: At 200Vac input voltage, 3-Phase 400/480V: At 380Vac input voltage. With rated output power.
- * 6: Not including EMI filter inrush current, less than 0.2mSec.
- * 7: 3-Phase 200V models: 170~265Vac, 3-Phase 400V models: 342~460Vac, 3-Phase 480V models: 342~528Vac. Constant load.
- * 8: From No-Load to Full-Load, constant input voltage. Measured at the sensing point in Remote Sense.
- * 9: For 10V~150V models: Measured with JEITA RC-9131C (1:1) probe. For 200~600V model: Measured with 100:1 probe.
- * 10: The maximum voltage on the power supply terminals must not exceed the rated voltage.
- * 11: From 10% to 90% or 90% to 10% of Rated Output Voltage, with rated, resistive load.
- * 12: From 90% to 10% of Rated Output Voltage.
- * 13: For load voltage change, equal to the unit voltage rating, constant input voltage.
- * 14: For 10V model, the ripple is measured at 20~100% of rated output voltage and rated output current. For other models, the ripple is measured at 10~100% of rated output voltage and rated output current. B,W 5Hz~1MHz.
- * 15: The Constant Current programming, readback and monitoring accuracy do not include the warm-up and Load regulation thermal drift.
- * 16: Measured at the sensing point.
- * 17: For 10V model Ta derating 2°C/100m.
- * 18 Signal and control ports interface cables length: Less than 3m, DC output power port cables length: Less than 30m.
- * 19 Max. ambient temperature for using IEEE is 40°C.
- * 20 For 10V model only: Max. output current for using IEEE is 400A up to 40°C and 450A up to 30°C.
- * 21: For 10V model only: For 3-Phase 200V efficiency is 88.5%
- * 22: Typ. at Ta=25°C, rated output power.

GENESYS™ 5kW SERIES SPECIFICATIONS 1000-5 - 1500-3.4

OUTPUT RATING		V	1000-5	1500-3.4
1. Rated output voltage (*1)		V	1000	1500
2. Rated output current (*2)		A	5	3.4
3. Rated output power		W	5000	5000
INPUT CHARACTERISTICS		V	1000	1500
1. Input voltage/freq. 3 phase, 3 wire + Ground (*4)		---	3-Phase, 200V models: 170~265Vac, 47~63Hz (Covers 200/230Vac) 3-Phase, 480V models: 342~528Vac, 47~63Hz (Covers 380/400/415/440/460/480Vac)	
2. Maximum Input current at 100% load	3-Phase, 200V models: 3-Phase, 480V models:	---	17.5A @ 200Vac 9.2A @ 380Vac	
3. Power Factor (Typ)		---	0.94 @ 200/380Vac, rated output power.	
4. Efficiency (Typ) (*5) (*3)		%	92	92
5. Inrush current (*6)		A	Less than 65A	
CONSTANT VOLTAGE MODE		V	1000	1500
1. Max. Line regulation (*7)		---	0.01% of rated output voltage	
2. Max. Load regulation (*8)		---	0.01% of rated output voltage +5mV	
3. Ripple and noise (p-p, 20MHz) (*9)		mV	900	900
4. Ripple r.m.s. 5Hz~1MHz (*9)		mV	200	200
5. Temperature coefficient		PPM/°C	50PPM/°C from rated output voltage, following 30 minutes warm-up.	
6. Temperature stability		---	0.01% of rated Vout over 8hrs interval following 30 minutes warm-up. Constant line, load & temp.	
7. Warm-up drift		---	Less than 0.05% of rated output voltage+2mV over 30 minutes following power on.	
8. Remote sense compensation/wire (*10)		V	5	5
9. Up-prog. Response time (*11)		mS	150	150
10. Down-prog. response time:	Full load (*11)	mS	100	100
	No load (*12)	mS	3000	3000
11. Transient response time		mS	Time for output voltage to recover within 0.5% of its rated output for a load change 10~90% of rated output current. Output set-point: 10~100%, Local sense. 2mS typical.	
12. Start up delay		Sec	Less than 5 Sec	
13. Hold up time		mS	5mS typical. Rated output power.	
CONSTANT CURRENT MODE		V	1000	1500
1. Max. Line regulation (*7)		---	0.05% of rated output current.	
2. Max. Load regulation (*13)		---	0.08% of rated output current.	
3. Ripple r.m.s. @ rated voltage. B.W 5Hz~1MHz (*14)		mA	≤7	≤4
4. Temperature coefficient		PPM/°C	70PPM/°C from rated output current, following 30 minutes warm-up.	
5. Temperature stability		---	0.01% of rated Iout over 8hrs. interval following 30 minutes warm-up. Constant line, load & temperature.	
6. Warm-up drift		---	Less than +/-0.15% of rated output current over 30 minutes following power on.	
ANALOG PROGRAMMING AND MONITORING (ISOLATED FROM THE OUTPUT)				
1. Vout voltage programming		---	0~100%, 0~5V or 0~10V, user selectable. Accuracy and linearity: +/-0.15% of rated Vout.	
2. Iout voltage programming (*15)		---	0~100%, 0~5V or 0~10V, user selectable. Accuracy and linearity: +/-0.4% of rated Iout.	
3. Vout resistor programming		---	0~100%, 0~5/10Kohm full scale, user selectable. Accuracy and linearity: +/-0.5% of rated Vout.	
4. Iout resistor programming (*15)		---	0~100%, 0~5/10Kohm full scale, user selectable. Accuracy and linearity: +/-0.5% of rated Iout.	
5. Output voltage monitor		---	0~5V or 0~10V, user selectable. Accuracy: +/-0.5% of rated Vout.	
6. Output current monitor (*15)		---	0~5V or 0~10V, user selectable. Accuracy: +/-0.5% of rated Iout.	
SIGNALS AND CONTROLS (ISOLATED FROM THE OUTPUT)				
1. Power supply OK #1 signal		---	Power supply output monitor. Open collector. Output On: On. Output Off: Off. Maximum Voltage: 30V, Maximum Sink Current: 10mA.	
2. CV/CC signal		---	CV/CC Monitor. Open collector. CC mode: On. CV mode: Off. Maximum Voltage: 30V, Maximum Sink Current: 10mA.	
3. LOCAL/REMOTE Analog control		---	Enable/Disable analog programming control by electrical signal or dry contact. Remote: 0~0.6V or short. Local: 2~30V or open.	
4. LOCAL/REMOTE Analog signal		---	Analog programming control monitor signal. Open collector. Remote: On. Local: Off. Maximum Voltage: 30V, Maximum Sink Current: 10mA.	
5. ENABLE/DISABLE signal		---	Enable/Disable PS output by electrical signal or dry contact. 0~0.6V or short, 2~30V or open. User selectable logic.	
6. INTERLOCK (ILC) control		---	"Enable/Disable PS output by electrical signal or dry contact. Output ON: 0~0.6V or short. Output OFF: 2~30V or open."	
7. Programmed signals		---	Two open drain programmable signals. Maximum voltage 25V, Maximum sink current 100mA (Shunted by 27V zener)	
8. TRIGGER IN / TRIGGER OUT signals		---	Maximum low level input voltage = 0.8V, Minimum high level input voltage = 2.5V, Maximum high level input = 5V positive edge trigger: tw=10us minimum. Tr, Tf=1us Maximum, Min delay between 2 pulses 1ms.	
9. DAISY_IN/SO control signal		---	By electrical Voltage: 0~0.6V/2~30V or dry contact.	
10. DAISY_OUT/PS_OK #2 signal		---	4~5V=OK, 0V (500ohm impedance)=Fail	
FUNCTIONS AND FEATURES				
1. Parallel operation		---	Possible. Up to four (4) identical units in Master/Slave mode. Refer to instruction manual. For more power please consult with Factory.	
2. Series operation		---	Not Possible	
3. Daisy chain		---	Power supplies can be connected in Daisy chain to synchronize their turn-on and turn-off.	
4. Constant power control		---	Limits the output power to a programmed value. Programming via the communication ports or the front panel.	
5. Output resistance control		---	Emulates series resistance. Resistance range: 1~1000mΩ. Programming via the communication ports or the front panel.	
6. Slew rate control		---	Programmable Output rise and Output fall slew rate. Programming range: 0.0001~999.99 V/mSec. or A/mSec. Programming via the communication ports or the front panel.	
7. Arbitrary waveforms		---	Profiles of up to 100 steps can be stored in 4 memory cells. Activation by command via the communication ports or by the front panel.	
PROGRAMMING AND READBACK (USB, LAN, RS232/485, Optional IEEE(*19)(*20) Interfaces)		V	1000	1500
1. Vout programming accuracy (*16)		---	0.05% of rated output voltage	
2. Iout programming accuracy (*15)		---	0.1% of actual output current+0.2% of rated output current	
3. Vout programming resolution		---	0.002% of rated output voltage	
4. Iout programming resolution		---	0.003% of rated output current	
5. Vout readback accuracy		---	0.1% of rated output voltage	
6. Iout readback accuracy (*15)		---	0.2% of rated output current	
7. Vout readback resolution (of rated output voltage)		%	0.011%	0.007%
8. Iout readback resolution (of rated output current)		%	0.002%	0.003%

GENESYS™ 5KW SERIES SPECIFICATIONS 1000-5 - 1500-3.4

PROTECTIVE FUNCTIONS	V	1000	1500
1.Foldback protection	---	Output shut-down when power supply changes mode from CV or Power Limit to CC mode or from CC or Power Limit to CV mode. User presetable. Reset by AC input recycle in AutoStart mode, by Power switch, by OUTPUT button, by rear panel or by communication.	
2.Over-voltage protection (OVP)	---	Output shut-down. Reset by AC input recycle in autostart mode, by Power Switch, by OUTPUT button, by rear panel or by communication.	
3.Over-voltage programming range	V	5~1212.75	5~1653.75
4.Over-voltage programming accuracy	---	+/-1% of rated output voltage	
5.Output under voltage limit (UVL)	---	Prevents from adjusting Vout below limit. Does not apply in analog programming. Preset by front panel or communication port.	
6.Over temperature protection	---	Shuts down the output. Auto recovery by autostart mode.	
7. Output under voltage protection (UVP)	---	Prevents adjustment of Vout below limit. P.S output turns Off during under voltage condition. Reset by AC input recycle in autostart mode, by Power Switch, by OUTPUT button, by rear panel or by communication.	

FRONT PANEL		
1.Control functions	---	Multiple options with 2 Encoders
	---	Vout/Iout/Power Limit manual adjust
	---	OVP/UVL/UVP manual adjust
	---	Protection Functions - OVP, UVL,UVP, Foldback, OCL, ENA, ILC
	---	Communication Functions - Selection of LAN,IEEE,RS232,RS485,USB or Optional communication interface.
	---	Output ON/OFF, Front Panel Lock.
	---	Communication Functions - Selection of Baud Rate, Address, IP and communication language.
	---	Analog Control Functions - Selection Voltage/resistive programming, 5V/10V, 5K/10K programming
	---	Analog Monitor Functions - Selection of Voltage/Current Monitoring 5V/10V.
2.Display	---	Vout: 4 digits, accuracy: 0.05% of rated output voltage +/-1 count.
	---	Iout: 4 digits, accuracy: 0.2% of rated output current +/-1 count.
3.Front Panel Buttons Indications	---	OUTPUT ON, ALARM, PREVIEW, FINE, COMMUNICATION, PROTECTION,CONFIGURATION, SYSTEM, SEQUENCER.
4. Front Panel Display Indications	---	Voltage, Current, Power, CV, CC, CP, External Voltage, External Current, Address, LFP, Autostart, Safetstart, Foldback V/I, Remote (communication), RS/USB/LAN/IEEE communication, Trigger, Load/Store Cell.

ENVIRONMENTAL CONDITIONS		
1.Operating temperature	---	0~50°C, 100% load.
2.Storage temperature	---	-30~85°C
3.Operating humidity	%	20~90% RH (no condensation).
4.Storage humidity	%	10~95% RH (no condensation).
5.Altitude (*17)	---	Operating: 10000ft (3000m), output current derating 2%/100m or Ta derating 1°C/100m above 1500m. Non operating: 40000ft (12000m).

MECHANICAL		
1.Cooling	---	Forced air cooling by internal fans. Air flow direction: From front panel to power supply rear
2.Weight	kg	Less than 8.5Kg.
3.Dimensions (WxHxD)	mm	W: 423, H: 43.6, D: 486.5 (Without busbars and busbars cover), W: 423, H: 43.6, D: 598.1 (Including busbars and busbars cover) Refer to Outline drawing.
4.Vibration	---	MIL-810G, method 514.6, Procedure I, test condition Annex C - 2.1.3.1
5.Shock	---	Less than 20G, half sine, 11mSec. Unit is unpacked.

SAFETY/EMC		
1. Safety standards:	Safety	UL61010-1, CSA22.2 No.61010-1, IEC61010-1, EN61010-1.
1.1. Interface classification	---	Output & J8 (sense) are hazardous, J1, J2, J3, J4, J5, J6, J7 & J9 (communication options) are Non Hazardous.
1.2 Withstand voltage	---	Input - Output & J8 (sense), J1, J2, J3, J4, J5, J6, J7 and J9 (communicatoin options): 4000VDC 1min, Output & J8 (sense) - J1, J2, J3, J4, J5, J6, J7 and J9 (communicatoin options): 2000VDC 1min, Output & J8 (sense) - Ground: 3280VDC 1min. Input - Ground: 2835VDC 1min.
1.3 Insulation resistance	---	>100Mohm at 25°C, 70%RH, Output to Ground 500VDC.
2.EMC standards (*18)	---	IEC/EN61204-3 Industrial environment.
2.1. Conducted emmission	---	IEC/EN61204-3 Industrial environment, Annex H table H.1 , FCC Part 15-A, VCCI-A.
2.2. Radiated emission	---	IEC/EN61204-3 Industrial environment, Annex H table H.3 and H4, FCC Part 15-A, VCCI-A

Unless otherwise noted, specifications are warranted over the ambient temperature range of 0° to 50° C.

- *1: Minimum voltage is guaranteed to maximum 0.1% of rated output voltage.
- *2: Minimum current is guaranteed to maximum 0.2% of rated output current.
- *3: Typ. at Ta=25°C, rated output power.
- *4: For cases where conformance to various safety standards (UL, IEC, etc...) is required, to be described as 190-240Vac (50/60Hz) for 3-Phase models.
- *5: 3-Phase 200V models: At 200Vac input voltage, 3-Phase 480V: At 380Vac input voltage. With rated output power.
- *6: Not including EMI filter inrush current, less than 0.2mSec.
- *7: 3-Phase 200V models: 170~265Vac, 3-Phase 480V models: 342~528Vac. Constant load.
- *8: From No-Load to Full-Load, constant input voltage. Measured at the sensing point in Remote Sense.
- *9: Measured with 100:1 probe.
- *10: The maximum voltage on the power supply terminals must not exceed the rated voltage.
- *11: From 10% to 90% or 90% to 10% of Rated Output Voltage, with rated, resistive load.
- *12: From 90% to 10% of Rated Output Voltage.
- *13: For load voltage change, equal to the unit voltage rating, constant input voltage.
- *14: The ripple is measured at 10~100% of rated output voltage and rated output current. 8.W 5Hz~1MHz.
- *15: The Constant Current programming, readback and monitoring accuracy do not include the warm-up and Load regulation thermal drift.
- *16: Measured at the sensing point.
- *17: Max. ambient temperature for using IEEE is 40°C.
- *18 Signal and control ports interface cables length: Less than 3m, DC output power port cables length: Less than 30m.

GENESYS™ 7.5kW SERIES SPECIFICATIONS

OUTPUT RATING		G	20-375	30-250	40-188	60-125	80-94	100-75	150-50	200-37.5	300-25	600-12.5	1000-7.5	1500-5	
1. Rated output voltage(*1)	V	20	30	40	60	80	100	150	200	300	600	1000	1500		
2. Rated output current (*2)	A	375	250	188	125	94	75	50	37.5	25	12.5	7.5	5		
3. Rated output power	W	7500	7500	7520	7500	7520	7500	7500	7500	7500	7500	7500	7500	7500	
INPUT CHARACTERISTICS		V	20	30	40	60	80	100	150	200	300	600	1000	1500	
1. Input voltage/freq. 3 phase, 3 wire+ground (*4)	---	3-Phase, 200V models: 170~265Vac, 47~63Hz (Covers 200/230Vac). 3-Phase, 480V models: 342~528Vac, 47~63Hz (Covers 380/400/415/440/460/480Vac).													
2. Maximum Input current at 100% load	3-Phase, 200V models: 3-Phase, 480V models:	---	25.5A @ 200Vac. 13.5A @ 380Vac.												
3. Power Factor (Typ.)	---	0.94 @ 200/380Vac, rated output power.													
4. Efficiency (Typ.) (*5) (*3)	%	91	91	91	91	91	91	91	91	91	91	92	92	92	
5. Inrush current (*6)	A	Less than 65A.													
CONSTANT VOLTAGE MODE		V	20	30	40	60	80	100	150	200	300	600	1000	1500	
1. Max. Line regulation (*7)	---	0.01% of rated output voltage.													
2. Max. Load regulation (*8)	---	0.01% of rated output voltage +5mV.													
3. Ripple and noise (p-p, 20MHz) (*9)	mV	80	80	80	80	90	90	150	250	150	450	1100	1300		
4. Ripple r.m.s. 5Hz~1MHz (*9)	mV	10	10	8	12	15	15	20	45	60	100	250	500		
5. Temperature coefficient	---	50PPM/°C from rated output voltage, following 30 minutes warm-up.													
6. Temperature stability	---	0.01% of rated Vout over 8hrs. interval following 30 minutes warm-up. Constant line, load & temperature.													
7. Warm-up drift	---	Less than 0.05% of rated output voltage +2mV over 30 minutes following power on.													
8. Remote sense compensation/wire (*10)	V	2	5	5	5	5	5	5	5	5	5	5	5	5	
9. Up-prog. response time (*11)	mS	30	30	30	50	50	50	50	50	50	100	150	200		
10. Down-prog. response time	Full load (*11)	50	80	80	80	100	100	100	100	100	100	100	100	100	
	No load (*12)	600	500	1000	1000	1000	1500	2500	2000	3000	3000	3000	3000	3000	
11. Transient response time	---	Time for output voltage to recover within 0.5% of its rated output for a load change 10~90% of rated output current. Output set point: 10~100%, Local sense. Less than 1mS for models up to and including 100V. 2mS for models above 100V.													
12. Start up delay	---	Less than 5Sec.													
13. Hold-up time	---	5mS Typical. Rated output power.													
CONSTANT CURRENT MODE		V	20	30	40	60	80	100	150	200	300	600	1000	1500	
1. Max. Line regulation (*7)	---	0.05% of rated output current.													
2. Max. Load regulation (*13)	---	0.08% of rated output current.													
3. Ripple r.m.s. 5Hz~1MHz (*14)	mA	≤900	≤500	≤300	≤150	≤100	≤70	≤45	≤20	≤15	≤14	≤10	≤5		
4. Temperature coefficient	PPM/°C	20V~100V models: 100PPM/OC from rated output current, following 30 minutes warm-up. 150V~1500V models: 70PPM/OC from rated output current, following 30 minutes warm-up.													
5. Temperature stability	---	0.01% of rated Iout over 8hrs. interval following 30 minutes warm-up. Constant line, load & temperature.													
6. Warm-up drift	---	20V~100V models: Less than +/-0.25% of rated output current over 30 minutes following power on. 150V~1500V models: Less than +/-0.15% of rated output current over 30 minutes following power on.													
ANALOG PROGRAMMING AND MONITORING (ISOLATED FROM THE OUTPUT)		---													
1. Vout voltage programming	---	0~100%, 0~5V or 0~10V, user selectable. Accuracy and linearity: +/-0.15% of rated Vout.													
2. Iout voltage programming (*15)	---	0~100%, 0~5V or 0~10V, user selectable. Accuracy and linearity: +/-0.4% of rated Iout.													
3. Vout resistor programming	---	0~100%, 0~5/10KΩ full scale, user selectable. Accuracy and linearity: +/-0.5% of rated Vout.													
4. Iout resistor programming (*15)	---	0~100%, 0~5/10KΩ full scale, user selectable. Accuracy and linearity: +/-0.5% of rated Iout.													
5. Output voltage monitor	---	0~5V or 0~10V, user selectable. Accuracy: +/-0.5% of rated Vout.													
6. Output current monitor (*15)	---	0~5V or 0~10V, user selectable. Accuracy: +/-0.5% of rated Iout.													
SIGNALS AND CONTROLS (ISOLATED FROM THE OUTPUT)		---													
1. Power supply OK #1 signal	---	Power supply output monitor. Open collector. Output On: On. Output Off: Off. Maximum Voltage: 30V. Maximum Sink Current: 10mA.													
2. CV/CC signal	---	CV/CC Monitor. Open collector. CC mode: On. CV mode: Off. Maximum Voltage: 30V. Maximum Sink Current: 10mA.													
3. LOCAL/REMOTE Analog control	---	Enable/Disable analog programming control by electrical signal or dry contact. Remote: 0~0.6V or short. Local: 2~30V or open.													
4. LOCAL/REMOTE Analog signal	---	Analog programming control monitor signal. Open collector. Remote: On. Local: Off. Maximum Voltage: 30V. Maximum Sink Current: 10mA.													
5. ENABLE/DISABLE signal	---	Enable/Disable PS output by electrical signal or dry contact. 0~0.6V or short, 2~30V or open. User selectable logic.													
6. INTERLOCK (ILC) control	---	Enable/Disable PS output by electrical signal or dry contact. Output ON: 0~0.6V or short. Output OFF: 2~30V or open.													
7. Programmed signals	---	Two open drain programmable signals. Maximum voltage 25V. Maximum sink current 100mA (shunted by 27V zener).													
8. TRIGGER IN / TRIGGER OUT signals	---	Maximum low level input voltage = 0.8V. Minimum high level input voltage = 2.5V. Maximum high level input = 5V positive edge trigger: tw = 10us minimum. Tr, Tf = 1us maximum. Min delay between 2 pulses 1ms.													
9. DAISY_IN/SO control signal	---	By electrical Voltage: 0~0.6V/2~30V or dry contact.													
10. DAISY_OUT/PS_OK #2 signal	---	4~5V = OK, 0V (500Ω impedance) = Fail.													
FUNCTIONS AND FEATURES		---													
1. Parallel operation	---	Possible. Up to 4 identical units in Master/Slave mode. Refer to instruction manual.													
2. Series operation	---	Possible. Two identical units. Refer to instruction manual.													
3. Daisy chain	---	Power supplies can be connected in Daisy chain to synchronize their turn-on and turn-off.													
4. Constant power control	---	Limits the output power to a programmed value. Programming via the communication ports or the front panel.													
5. Output resistance control	---	Emulates series resistance. Resistance range: 1~1000mΩ. Programming via communication ports or front panel.													
6. Slew rate control	---	Programmable Output rise and Output fall slew rate. Programming range: 0.0001~999.99 V/mS. or A/mS. Programming via communication ports or front panel.													
7. Arbitrary waveforms	---	Profiles of up to 100 steps can be stored in 4 memory cells. Activation by command via communication ports or front panel.													
PROGRAMMING AND READBACK (USB, LAN, RS232/485, Optional (*17) (*20) Interfaces)		V	20	30	40	60	80	100	150	200	300	600	1000	1500	
1. Vout programming accuracy (*16)	---	0.05% of rated output voltage.													
2. Iout programming accuracy (*15)	---	0.1% of actual output current +0.2% of rated output current.													
3. Vout programming resolution	---	0.002% of rated output voltage.													
4. Iout programming resolution	---	0.002% of rated output current.													
5. Vout readback accuracy	---	0.05% of rated output voltage.													
6. Iout readback accuracy (*15)	---	0.2% of rated output current.													
7. Vout readback resolution of rated output	%	0.006%	0.004%	0.003%	0.002%	0.002%	0.011%	0.007%	0.005%	0.004%	0.002%	0.011%	0.007%		
8. Iout readback resolution of rated output current	%	0.003%	0.005%	0.006%	0.009%	0.002%	0.002%	0.003%	0.003%	0.005%	0.009%	0.002%	0.003%		

GENESYS™ 7.5kW SERIES SPECIFICATIONS

PROTECTIVE FUNCTIONS	V	20	30	40	60	80	100	150	200	300	600	1000	1500
1.Foldback protection	---	Output shut-down when power supply changes mode from CV or Power Limit to CC mode or from CC or Power Limit to CV mode. User presetable. Reset by AC input recycle in autostart mode, by Power Switch, by OUTPUT button, by rear panel or by communication.											
2.Over-voltage protection (OVP)	---	Output shut-down. Reset by AC input recycle in autostart mode, by Power Switch, by OUTPUT button, by rear panel or by communication.											
3.Over-voltage programming range	V	1~24	2~36	2~44.1	5~66.15	5~88.2	5~110.25	5~165.37	5~220.5	5~330.75	5~661.5	5~1212.75	5~1653.75
4.Over-voltage programming accuracy	---	+/-1% of rated output voltage.											
5.Output under voltage limit (UVL)	---	Prevents from adjusting Vout below limit. Does not apply in analog programming. Preset by front panel or communication port.											
6.Over temperature protection	---	Shuts down the output. Auto recovery by autostart mode.											
7.Output under voltage protection (UVP)	---	Prevents adjustment of Vout below limit. P.S output turns Off during under voltage condition. Reset by AC input recycle in autostart mode, by Power Switch, by OUTPUT button, by rear panel or by communication.											
FRONT PANEL													
1.Control functions	---	Multiple options with 2 Encoders											
	---	Vout/Iout/Power Limit manual adjust											
	---	OVP/UVL/UVP manual adjust											
	---	Protection Functions - OVP, UVL, UVP, Foldback, OCL, ENA, ILC											
	---	Communication Functions - Selection of LAN, IEEE, RS232, RS485, USB or Optional communication interface.											
	---	Output ON/OFF. Front Panel Lock.											
	---	Communication Functions - Selection of Baud Rate, Address, IP and communication language.											
	---	Analog Control Functions - Selection Voltage/resistive programming, 5V/10V, 5K/10K programming											
	---	Analog Monitor Functions - Selection of Voltage/Current Monitoring 5V/10V.											
2.Display	---	Vout: 4 digits, accuracy: 0.05% of rated output voltage +/-1 count.											
	---	Iout: 4 digits, accuracy: 0.2% of rated output current +/-1 count.											
3.Front Panel Buttons Indications	---	OUTPUT ON, ALARM, PREVIEW, FINE, COMMUNICATION, PROTECTION, CONFIGURATION, SYSTEM, SEQUENCER.											
4. Front Panel Display Indications	---	Voltage, Current, Power, CV, CC, CP, External Voltage, External Current, Address, LFP, Autostart, Safetstart, Foldback V/I, Remote (communication), RS/USB/LAN/IEEE communication, Trigger, Load/Store Cell.											
ENVIRONMENTAL CONDITIONS													
1.Operating temperature	---	0~50°C, 100% load.											
2.Storage temperature	---	-30~85°C											
3.Operating humidity	%	20~90% RH (no condensation).											
4.Storage humidity	%	10~95% RH (no condensation).											
5.Altitude (*17)	---	Operating: 10000ft (3000m), output current derating 2%/100m or Ta derating 1°C/100m above 2000m. Non operating: 40000ft (12000m).											
MECHANICAL													
1.Cooling	---	Forced air cooling by internal fans. Airflow direction: From front panel to power supply rear.											
2.Weight	kg	Less than 8.5Kg.											
3.Dimensions (WxHxD)	mm	W: 423, H: 43.6, D: 486.5 (Without busbars and busbars cover), W: 423, H: 43.6, D: 598.1 (Including busbars and busbars cover). Refer to Outline drawing.											
4.Vibration	---	MIL-810G, method 514.6, Procedure I, test condition Annex C - 2.1.3.1											
5.Shock	---	Less than 20G, half sine, 11mS. Unit is unpacked.											
SAFETY/EMC													
1.Applicable standards:	Safety	---	UL61010-1, CSA22.2 No.61010-1, IEC61010-1, EN61010-1.										
1.1. Interface classification		---	Vout<50V Models: Output, J1, J2, J3, J4, J5, J6, J7, J8 (sense) & J9 (communication options) are Non Hazardous. 60<Vout<1500V Models: Output & J8 (sense) are hazardous, J1, J2, J3, J4, J5, J6, J7 & J9 (communication options) are Non Hazardous.										
1.2 Withstand voltage		---	Vout<50V Models: Input - Output & J8 (sense), J1, J2, J3, J4, J5, J6, J7 & J9 (communication options): 4242VDC 1min, Input - Ground: 2835VDC 1min. 60V<Vout<100V Models: Input - Output & J8 (sense), J1, J2, J3, J4, J5, J6, J7 & J9 (communication options): 4242VDC 1min, Output & J8 (sense) - J1, J2, J3, J4, J5, J6, J7 & J9 (communication options): 850VDC 1min, Output & J8 (sense) - Ground: 1500VDC 1min, Input - Ground: 2835VDC 1min. 100V<Vout<600V Models: Input - Output & J8 (sense), J1, J2, J3, J4, J5, J6, J7 and J9 (communication options): 4242VDC 1min, Output & J8 (sense) - J1, J2, J3, J4, J5, J6, J7 & J9 (communication options): 1275VDC 1min, Output & J8 (sense) - Ground: 2500VDC 1min, Input - Ground: 2835VDC 1min. 1000V<Vout<1500V Models: Input - Output & J8 (sense), J1, J2, J3, J4, J5, J6, J7 and J9 (communication options): 4000VDC 1min, Output & J8 (sense) - J1, J2, J3, J4, J5, J6, J7 & J9 (communication options): 2000VDC 1min, Output & J8 (sense) - Ground: 3280VDC 1min, Input - Ground: 2835VDC 1min.										
1.3.Isolation resistance		---	100Mohm at 25°C, 70%RH. Output to Ground 500VDC										
2.EMC standards (*18)		---	IEC/EN61204-3 Industrial environment, Annex H table H.1 , FCC Part 15-A, VCCI-A.										
2.1.Conducted emission		---	IEC/EN61204-3 Industrial environment, Annex H table H.3 and H4, FCC Part 15-A, VCCI-A										
2.2.Radiated emission		---	IEC/EN61204-3 Industrial environment										

Unless otherwise noted, specifications are warranted over the ambient temperature range of 0° to 50° C.

NOTES:

**: Coming soon

- *1: Minimum voltage is guaranteed to maximum 0.15% of rated output voltage for 20V and 30V / 0.1% of rated output voltage for 40V and 1500V
- *2: Minimum current is guaranteed to maximum 0.2% of rated output current.
- *3 Typ. at Ta=25°C, rated output power.
- *4: For cases where conformance to various safety standards (UL, IEC, etc...) is required, to be described as 190-240Vac (50/60Hz) for 3-Phase 200V models and 380~480Vac (50/60Hz) for 3-Phase 480V models.
- *5: 3-Phase 200V models: At 200Vac input voltage, 3-Phase 400/480V: At 380Vac input voltage. With rated output power.
- *6: Not including EMI filter inrush current, less than 0.2mS.
- *7: 3-Phase 200V models: 170~265Vac, 3-Phase 480V models: 342~528Vac. Constant load.
- *8: From No-Load to Full-Load, constant input voltage. Measured at the sensing point in Remote Sense.
- *9: For 20V~150V models: Measured with JEITA RC-9131C (1:1) probe. For 200~1500V models: Measured with 100:1 probe.
- *10: The maximum voltage on the power supply terminals must not exceed the rated voltage.
- *11: From 10% to 90% of Rated Output Voltage at rated resistive load.
- *12: From 90% to 10% of Rated Output Voltage.
- *13: For load voltage change, equal to the unit voltage rating, constant input voltage.
- *14: The ripple is measured at 10~100% of rated output voltage and rated output current. B.W 5Hz~1MHz.
- *15: The Constant Current programming, readback and monitoring accuracy do not include the warm-up and Load regulation thermal drift.
- *16: Measured at the sensing point.
- *17 Max. ambient temperature for IEEE is 40°C.
- *18: Signal and control ports interface cables length: Less than 3m, DC output power port cables length: Less than 30m.

GENESYS™ GSP10kW SERIES SPECIFICATIONS

OUTPUT RATING		GSP	10-1000	20-500	30-340	40-250	50-200	60-170	80-130	100-100	150-68	200-50	300-34	400-26	500-20	600-17
1. Rated output voltage (*1)		V	10	20	30	40	50	60	80	100	150	200	300	400	500	600
2. Rated output current (*2)		A	1000 (*3)	500	340	250	200	170	130	100	68	50	34	26	20	17
3. Rated output power		kW	10	10	10.2	10	10	10.2	10.4	10	10.2	10	10.2	10.4	10	10.2
INPUT CHARACTERISTICS		V	10	20	30	40	50	60	80	100	150	200	300	400	500	600
1. Input voltage/freq. 3 phase, 3 wire + Ground (*4)		---	3-Phase, 200V models: 170~265Vac, 47~63Hz (Covers 200/230Vac) 3-Phase, 400V models: 342~460Vac, 47~63Hz (Covers 380/400/415Vac) 3-Phase, 480V models: 342~528Vac, 47~63Hz (Covers 380/400/415/440/460/480Vac)													
2. Maximum Input current at 100% load		3-Phase, 200V models: 3-Phase, 400V models: 3-Phase, 480V models:	35A @ 200Vac 18.4A @ 380Vac 18.4A @ 380Vac													
3. Power Factor (Typ)		---	0.94 @ 200/380Vac, rated output power.													
4. Efficiency (Typ) (*5) (*22)		%	89 (*21)	90	91	91	91	91	91	91	91	91	92	92	91	92
5. Inrush current (*6)		A	Less than 100A													
6. AC line phase imbalance		%	< 5%													
CONSTANT VOLTAGE MODE		V	10	20	30	40	50	60	80	100	150	200	300	400	500	600
1. Max. Line regulation (*7)		---	0.01% of rated output voltage													
2. Max. Load regulation (*8)		---	0.01% of rated output voltage +5mV													
3. Ripple and noise (p-p, 20MHz) (*9)		mV	75	75	75	75	75	75	80	90	120	200	200	400	450	480
4. Ripple r.m.s. 5Hz~1MHz (*9)		mV	8	10	12	12	12	12	15	15	20	45	60	80	80	100
5. Temperature coefficient		PPM/°C	50PPM/°C from rated output voltage, following 30 minutes warm-up.													
6. Temperature stability		---	0.01% of rated Vout over 8hrs interval following 30 minutes warm-up. Constant line, load & temp.													
7. Warm-up drift		---	Less than 0.05% of rated output voltage+2mV over 30 minutes following power on.													
8. Remote sense compensation/wire (*10)		V	2	2	5	5	5	5	5	5	5	5	5	5	5	5
9. Up-prog. Response time (*11)		mS	30	30	30	30	50	50	50	50	50	50	50	100	100	100
10. Down-prog. response time:		Full load (*11)	mS	50	50	80	80	80	80	100	100	100	100	150	200	200
		No load (*12)	mS	300	600	800	900	950	1000	1200	1900	2000	2500	3000	4000	4000
11. Transient response time		mS	Time for output voltage to recover within 0.5% of its rated output for a load change 10~90% of rated output current. Output set-point: 10~100%, Local sense. Less than 1mS, for models up to and including 100V. 2mS, for models above 100V.													
12. Start up delay		Sec	Less than 7 Sec													
CONSTANT CURRENT MODE		---	0.05% of rated output current.													
1. Max. Line regulation (*7)		---	0.08% of rated output current.													
2. Max. Load regulation (*13)		---	0.08% of rated output current.													
3. Ripple r.m.s. @ 10% rated voltage. B.W 5Hz~1MHz. (*14)		mA	1500	1200	600	300	200	150	100	70	45	45	15	15	12	10
4. Ripple r.m.s. @ 100% rated voltage. B.W 5Hz~1MHz. (TA25°C)		mA	1200	700	300	150	100	75	50	35	23	23	7.5	7.5	8	6
5. Temperature coefficient		PPM/°C	10V~100V 100PPM/°C from rated output current, following 30 minutes warm-up. 150V~600V 70PPM/°C from rated output current, following 30 minutes warm-up.													
6. Temperature stability		---	0.01% of rated Iout over 8hrs. interval following 30 minutes warm-up. Constant line, load & temperature.													
7. Warm-up drift		---	10V~100V model: Less than +/-0.25% of rated output current over 30 minutes following power on. 150V~600V: Less than +/-0.15% of rated output current over 30 minutes following power on.													
ANALOG PROGRAMMING AND MONITORING (ISOLATED FROM THE OUTPUT)		---	0~100%, 0~5V or 0~10V, user selectable. Accuracy and linearity: +/-0.15% of rated Vout.													
1. Vout voltage programming		---	0~100%, 0~5V or 0~10V, user selectable. Accuracy and linearity: +/-0.4% of rated Iout.													
2. Iout voltage programming (*15)		---	0~100%, 0~5/10Kohm full scale, user selectable. Accuracy and linearity: +/-0.5% of rated Vout.													
3. Vout resistor programming		---	0~100%, 0~5/10Kohm full scale, user selectable. Accuracy and linearity: +/-0.5% of rated Iout.													
4. Iout resistor programming (*15)		---	0~5V or 0~10V, user selectable. Accuracy: +/-0.5%. Of rated Vout.													
5. Output voltage monitor		---	0~5V or 0~10V, user selectable. Accuracy: +/-0.5%. Of rated Iout.													
6. Output current monitor (*15)		---	0~5V or 0~10V, user selectable. Accuracy: +/-0.5%. Of rated Iout.													
SIGNALS AND CONTROLS (ISOLATED FROM THE OUTPUT)		---	Power supply output monitor. Open collector. Output On: On. Output Off: Off. Maximum Voltage: 30V, Maximum Sink Current: 10mA.													
1. Power supply OK #1 signal		---	CV/CC Monitor. Open collector. CC mode: On. CV mode: Off. Maximum Voltage: 30V, Maximum Sink Current: 10mA.													
2. CV/CC signal		---	Enable/Disable analog programming control by electrical signal or dry contact. Remote: 0~0.6V or short. Local: 2~30V or open.													
3. LOCAL/REMOTE Analog control		---	analog programming control monitor signal. Open collector. Remote: On. Local: Off. Maximum Voltage: 30V, Maximum Sink Current: 10mA.													
4. LOCAL/REMOTE Analog signal		---	Enable/Disable PS output by electrical signal or dry contact. 0~0.6V or short, 2~30V or open. User selectable logic.													
5. ENABLE/DISABLE signal		---	Enable/Disable PS output by electrical signal or dry contact. Remote: 0~0.6V or short. Local: 2~30V or open.													
6. INTERLOCK (ILC) control		---	Two open drain programmable signals. Maximum voltage 25V, Maximum sink current 100mA (Shunted by 27V zener)													
7. Programmed signals		---	Maximum low level input voltage = 0.8V, Minimum high level input voltage = 2.5V, Maximum high level input = 5V positive edge trigger: tw=10us minimum. Tr, Tf=1us Maximum, Min delay between 2 pulses 1ms.													
8. TRIGGER IN / TRIGGER OUT signals		---	By electrical Voltage: 0~0.6V/2~30V or dry contact.													
9. DAISY_IN/SO control signal		---	4~5V=OK, 0V (500ohm impedance)=Fail													
10. DAISY_OUT/PS_OK #2 signal		---														
FUNCTIONS AND FEATURES		---	Possible. Up to four (4) identical GSP units. For more power please consult with Factory.													
1. Parallel operation		---	Consult with Factory													
2. Series operation		---	Power supplies can be connected in Daisy chain to synchronize their turn-on and turn-off.													
3. Daisy chain		---	Limits the output power to a programmed value. Programming via the communication ports or the front panel.													
4. Constant power control		---	Emulates series resistance. Resistance range: 1~1000mΩ. Programming via the communication ports or the front panel.													
5. Output resistance control		---	Programmable Output rise and Output fall slew rate. Programming range: 0.0001~999.99 V/mSec. or A/mSec. Programming via the communication ports or the front panel.													
6. Slew rate control		---	Profiles of up to 100 steps can be stored in 4 memory cells. Activation by command via the communication ports or by the front panel.													
7. Arbitrary waveforms		---														
PROGRAMMING AND READBACK (USB, LAN, RS232/485, Optional IEEE (*19)(*20) Interfaces)		V	10	20	30	40	50	60	80	100	150	200	300	400	500	600
1. Vout programming accuracy (*16)		---	0.05% of rated output voltage													
2. Iout programming accuracy (*15)		---	0.3% of rated output current													
3. Vout programming resolution		---	0.002% of rated output voltage													
4. Iout programming resolution		---	0.002% of rated output current													
5. Vout readback accuracy		---	0.05% of rated output voltage													
6. Iout readback accuracy (*15)		---	0.2% of rated output current													
7. Vout readback resolution (of rated output voltage)		%	0.011%	0.006%	0.004%	0.003%	0.003%	0.002%	0.002%	0.011%	0.007%	0.005%	0.004%	0.003%	0.003%	0.002%
8. Iout readback resolution (of rated output current)		%	0.012%	0.003%	0.004%	0.005%	0.006%	0.007%	0.009%	0.012%	0.002%	0.003%	0.003%	0.004%	0.006%	0.006%

GENESYS™ GSP15kW SERIES SPECIFICATIONS

OUTPUT RATING		GSP	10-1500	20-750	30-510	40-375	50-300	60-255	80-195	100-150	150-102	200-75	300-51	400-39	500-30	600-25.5	
1.Rated output voltage(*1)		V	10	20	30	40	50	60	80	100	150	200	300	400	500	600	
2.Rated output current (*2)		A	1500 (*3)	750	510	375	300	255	195	150	102	75	51	39	30	25.5	
3.Rated output power		kW	15	15	15.3	15	15	15.3	15.6	15	15.3	15	15.3	15.6	15	15.3	
INPUT CHARACTERISTICS		V	10	20	30	40	50	60	80	100	150	200	300	400	500	600	
1.Input voltage/freq. 3 phase, 3 wire + Ground (*4)		---	3-Phase, 200V models: 170~265Vac, 47~63Hz (Covers 200/230Vac) 3-Phase, 400V models: 342~460Vac, 47~63Hz (Covers 380/400/415Vac) 3-Phase, 480V models: 342~528Vac, 47~63Hz (Covers 380/400/415/440/460/480Vac)														
2. Maximum Input current at 100% load		3-Phase, 200V models: 3-Phase, 400V models: 3-Phase, 480V models:	52.5A @ 200Vac 27.6A @ 380Vac 27.6A @ 380Vac														
3.Power Factor (Typ)		---	0.94 @ 200/380Vac, rated output power.														
4.Efficiency (Typ) (*5) (*22)		%	89 (*21)	90	91	91	91	91	91	91	91	91	92	92	91	92	
5.Inrush current (*6)		A	Less than 150A														
6.AC line phase imbalance		%	< 5%														
CONSTANT VOLTAGE MODE		V	10	20	30	40	50	60	80	100	150	200	300	400	500	600	
1.Max. Line regulation (*7)		---	0.01% of rated output voltage														
2.Max. Load regulation (*8)		---	0.01% of rated output voltage +5mV														
3.Ripple and noise (p-p, 20MHz) (*9)		mV	75	75	75	75	75	75	80	90	120	200	200	400	450	480	
4.Ripple r.m.s. 5Hz~1MHz (*9)		mV	8	10	12	12	12	12	15	15	20	45	60	80	80	100	
5.Temperature coefficient		PPM/°C	50PPM/°C from rated output voltage, following 30 minutes warm-up.														
6.Temperature stability		---	0.01% of rated Vout over 8hrs interval following 30 minutes warm-up. Constant line, load & temp.														
7. Warm-up drift		---	Less than 0.05% of rated output voltage+2mV over 30 minutes following power on.														
8.Remote sense compensation/wire (*10)		V	2	2	5	5	5	5	5	5	5	5	5	5	5	5	
9.Up-prog. Response time (*11)		mS	30	30	30	30	50	50	50	50	50	50	50	100	100	100	
10.Down-prog.response time:		Full load (*11)	mS	50	50	80	80	80	80	100	100	100	100	100	150	200	200
		No load (*12)	mS	300	600	800	900	950	1000	1200	1900	2000	2500	3000	4000	4000	3000
11.Transient response time		mS	Time for output voltage to recover within 0.5% of its rated output for a load change 10~90% of rated output current. Output set-point: 10~100%, Local sense. Less than 1mS, for models up to and including 100V. 2mS, for models above 100V.														
12..Start up delay		Sec	Less than 7 Sec														
CONSTANT CURRENT MODE		V	10	20	30	40	50	60	80	100	150	200	300	400	500	600	
1.Max. Line regulation (*7)		---	0.05% of rated output current.														
2.Max. Load regulation (*13)		---	0.08% of rated output current.														
3.Ripple r.m.s. @ 10% rated voltage B.W 5Hz~1MHz. (*14)		mA	2000	1200	600	300	250	180	100	70	45	45	15	15	12	10	
4.Ripple r.m.s. @ 100% rated voltage. B.W 5Hz~1MHz. (TA 25°C)		mA	1200	700	300	150	130	90	60	35	23	23	7.5	7.5	8	6	
5.Temperature coefficient		PPM/°C	10V~100V 100PPM/°C from rated output current, following 30 minutes warm-up. 150V~600V 70PPM/°C from rated output current, following 30 minutes warm-up.														
6.Temperature stability		---	0.01% of rated Iout over 8hrs. interval following 30 minutes warm-up. Constant line, load & temperature.														
7. Warm-up drift		---	10V~100V model: Less than +/-0.25% of rated output current over 30 minutes following power on. 150V~600V: Less than +/-0.15% of rated output current over 30 minutes following power on.														
ANALOG PROGRAMMING AND MONITORING (ISOLATED FROM THE OUTPUT)																	
1.Vout voltage programming		---	0~100%, 0~5V or 0~10V, user selectable. Accuracy and linearity: +/-0.15% of rated Vout.														
2.Iout voltage programming (*15)		---	0~100%, 0~5V or 0~10V, user selectable. Accuracy and linearity: +/-0.4% of rated Iout.														
3.Vout resistor programming		---	0~100%, 0~5/10Kohm full scale, user selectable. Accuracy and linearity: +/-0.5% of rated Vout.														
4.Iout resistor programming (*15)		---	0~100%, 0~5/10Kohm full scale, user selectable. Accuracy and linearity: +/-0.5% of rated Iout.														
5.Output voltage monitor (*23)		---	0~5V or 0~10V, user selectable. Accuracy: +/-0.5% of rated Vout.														
6.Output current monitor (*15) (*23)		---	0~5V or 0~10V, user selectable. Accuracy: +/-0.5% of rated Iout.														
SIGNALS AND CONTROLS (ISOLATED FROM THE OUTPUT)																	
1. Power supply OK #1 signal		---	Power supply output monitor. Open collector. Output On: On. Output Off: Off. Maximum Voltage: 30V, Maximum Sink Current: 10mA.														
2. CV/CC signal		---	CV/CC Monitor. Open collector. CC mode: On. CV mode: Off. Maximum Voltage: 30V, Maximum Sink Current: 10mA.														
3. LOCAL/REMOTE Analog control		---	Enable/Disable analog programming control by electrical signal or dry contact. Remote: 0~0.6V or short. Local: 2~30V or open.														
4. LOCAL/REMOTE Analog signal		---	analog programming control monitor signal. Open collector. Remote: On. Local: Off. Maximum Voltage: 30V, Maximum Sink Current: 10mA.														
5. ENABLE/DISABLE Signal		---	Enable/Disable PS output by electrical signal or dry contact. 0~0.6V or short, 2~30V or open. User selectable logic.														
6. INTERLOCK (ILC) control		---	Enable/Disable PS output by electrical signal or dry contact. Remote: 0~0.6V or short. Local: 2~30V or open.														
7. Programmed signals		---	Two open drain programmable signals. Maximum voltage 25V, Maximum sink current 100mA (Shunted by 27V zener)														
8. TRIGGER IN / TRIGGER OUT signals		---	Maximum low level input voltage = 0.8V, Minimum high level input voltage = 2.5V, Maximum high level input = 5V positive edge trigger: tw=10us minimum. Tr,Tf=1us Maximum, Min delay between 2 pulses 1ms.														
9. DAISY_IN/SO control signal		---	By electrical Voltage: 0~0.6V/2~30V or dry contact.														
10. DAISY_OUT/PS_OK #2 signal		---	4~5V=OK, 0V (500ohm impedance)=Fail														
FUNCTIONS AND FEATURES																	
1. Parallel operation		---	Possible. Up to four (4) identical GSP units. For more power please consult with Factory.														
2. Series operation		---	Consult with Factory														
3. Daisy chain		---	Power supplies can be connected in Daisy chain to synchronize their turn-on and turn-off.														
4. Constant power control		---	Limits the output power to a programmed value. Programming via the communication ports or the front panel.														
5. Output resistance control		---	Emulates series resistance. Resistance range: 1~1000mΩ. Programming via the communication ports or the front panel.														
6. Slew rate control		---	Programmable Output rise and Output fall slew rate. Programming range: 0.0001~999.99 V/mSec. or A/mSec. Programming via the communication ports or the front panel.														
7. Arbitrary waveforms		---	Profiles of up to 100 steps can be stored in 4 memory cells. Activation by command via the communication ports or by the front panel.														
PROGRAMMING AND READBACK (USB, LAN, RS232/485, Optional IEEE (*19)(*20) Interfaces)		V	10	20	30	40	50	60	80	100	150	200	300	400	500	600	
1.Vout programming accuracy (*16)		---	0.05% of rated output voltage														
2.Iout programming accuracy (*15)		---	0.3% of rated output current														
3.Vout programming resolution		---	0.002% of rated output voltage														
4.Iout programming resolution		---	0.002% of rated output current														
5.Vout readback accuracy		---	0.05% of rated output voltage														
6.Iout readback accuracy (*15)		---	0.2% of rated output current														
7.Vout readback resolution (of rated output voltage)		%	0.011%	0.006%	0.004%	0.003%	0.003%	0.002%	0.002%	0.011%	0.007%	0.005%	0.004%	0.003%	0.003%	0.002%	
8.Iout readback resolution (of rated output current)		%	0.012%	0.003%	0.003%	0.004%	0.004%	0.005%	0.006%	0.008%	0.012%	0.002%	0.003%	0.003%	0.003%	0.005%	

GENESYS™ GSP10kW/15kW SERIES SPECIFICATIONS

PROTECTIVE FUNCTIONS	V	10	20	30	40	50	60	80	100	150	200	300	400	500	600	
1.Foldback protection	---	Output shut-down when power supply changes mode from CV or Power Limit to CC mode or from CC or Power Limit to CV mode. User presetable. Reset by AC input recycle in autostart mode, by Power Switch, by OUTPUT button, by rear panel or by communication.														
2.Over-voltage protection (OVP)	---	Output shut-down. Reset by AC input recycle in autostart mode, by OUTPUT button, by rear panel or by communication.														
3.Over-voltage programming range	V	0.5~12	1~24	2~36	2~44.1	5~55.125	5~66.15	5~88.2	5~110.25	5~165.37	5~220.5	5~330.75	5~441	5~551.25	5~661.5	
4.Over-voltage programming accuracy	---	+/-1% of rated output voltage														
5.Output under voltage limit (UVL)	---	Prevents from adjusting Vout below limit. Does not apply in analog programming. Preset by front panel or communication port.														
6.Over temperature protection	---	Shuts down the output. Auto recovery by autostart mode.														
7. Output under voltage limit (UVL)	---	Prevents adjustment of Vout below limit.														
8. Output under voltage protection (UVP)	---	Prevents adjustment of Vout below limit. P.S output turns Off during under voltage condition. Reset by AC input recycle in autostart mode, by Power Switch, by OUTPUT button, by rear panel or by communication.														
FRONT PANEL																
1.Control functions	---	Multiple options with 2 Encoders														
	---	Vout/Iout/Power Limit manual adjust														
	---	OVP/UVL/UVP manual adjust														
	---	Protection Functions - OVP, UVL, UVP, Foldback, OCL, ENA, ILC														
	---	Communication Functions - Selection of LAN, IEEE, RS232, RS485, USB or Optional communication interface.														
	---	Output ON/OFF. Front Panel Lock.														
	---	Communication Functions - Selection of Baud Rate, Address, IP and communication language.														
	---	Analog Control Functions - Selection Voltage/resistive programming, 5V/10V, 5K/10K programming														
	---	Analog Monitor Functions - Selection of Voltage/Current Monitoring 5V/10V.														
2.Display	---	Vout: 4 digits, accuracy: 0.05% of rated output voltage +/-1 count.														
	---	Iout: 4 digits, accuracy: 0.2% of rated output current +/-1 count.														
3.Front Panel Buttons Indications	---	OUTPUT ON, ALARM, PREVIEW, FINE, COMMUNICATION, PROTECTION, CONFIGURATION, SYSTEM, SEQUENCER.														
4. Front Panel Display Indications	---	Voltage, Current, Power, CV, CC, CP, External Voltage, External Current, Address, LFP, Autostart, Safetstart, Foldback V/I, Remote (communication), RS/USB/LAN/IEEE communication, Trigger, Load/Store Cell.														
ENVIRONMENTAL CONDITIONS																
1.Operating temperature	---	0~50°C, 100% load.														
2.Storage temperature	---	-30~85°C														
3.Operating humidity	%	20~90% RH (no condensation).														
4.Storage humidity	%	10~95% RH (no condensation).														
5.Altitude (*17)	---	Operating: 10000ft (3000m), output current derating 2%/100m or Ta derating 1°C/100m above 2000m. Non operating: 40000ft (12000m).														
MECHANICAL																
1.Cooling	---	Forced air cooling by internal fans. Air flow direction: from Front panel to power supply rear														
2.Weight	GSP 10kW	kg	Less than 15.5kg.													
3.Dimensions (WxHxD)	GSP 10kW	mm	W: 423, H: 88, D: 441.5 (Without busbars and busbars cover), W: 423, H: 88, D: 640 (Including busbars and busbars cover, and strain relief) (Refer to Outline drawing).													
2.Weight	GSP 15kW	kg	Less than 23.5kg.													
3.Dimensions (WxHxD)	GSP 15kW	mm	W: 423, H: 132.5, D: 441.5 (Without busbars and busbars cover), W: 423, H: 132.5, D: 640 (Including busbars and busbars cover, and strain relief) (Refer to Outline drawing).													
4.Vibration	---	MIL-810G, method 514.6, Procedure I, test condition Annex C - 2.1.3.1														
5.Shock	---	Less than 20G, half sine, 11mSec. Unit is unpacked.														
SAFETY/EMC																
1.Applicable standards:	Safety	---	UL61010-1, CSA22.2 No.L61010-1, IEC61010-1, ENL61010-1.													
1.1. Interface classification		---	Vout<50V Models: Output, J1, J2, J3, J4, J5, J6, J7, J8 (sense) & J9 (communication options) are Non Hazardous. 60<Vout<600V Models: Output & J8 (sense) are hazardous, J1, J2, J3, J4, J5, J6, J7 & J9 (communication options) are Non Hazardous.													
1.2 Withstand voltage		---	Vout<50V Models: Input - Output & J8 (sense), J1, J2, J3, J4, J5, J6, J7 & J9 (communication options): 4242VDC 1min, Input - Ground: 2835VDC 1min. 60V<Vout<100V Models: Input - Output & J8 (sense), J1, J2, J3, J4, J5, J6, J7 & J9 (communication options): 4242VDC 1min, Output & J8 (sense) - J1, J2, J3, J4, J5, J6, J7 & J9 (communication options): 850VDC 1min. Output & J8 (sense) - Ground: 1500VDC 1min, Input - Ground: 2835VDC 1min. 100V<Vout<600V Models: Input - Output & J8 (sense), J1, J2, J3, J4, J5, J6, J7 & J9 (communication options): 4242VDC 1min, Output & J8 (sense) - J1, J2, J3, J4, J5, J6, J7 & J9 (communication options): 1275VDC 1min. Output & J8 (sense) - Ground: 2500VDC 1min. Input - Ground: 2835VDC 1min.													
1.3 Insulation resistance		---	GSP10kW/15kW: 60 Mohm at 25°C, 70%RH. Output to Ground 500VDC													
2.Conducted emission		---	IEC/EN61204-3 Industrial environment, Annex H table H.1, FCC Part 15-A, VCCI-A.													
3.Radiated emission		---	IEC/EN61204-3 Industrial environment, Annex H table H.3 and H4, FCC Part 15-A, VCCI-A.													
4. EMC compliance	EMC(*18)	---	IEC/EN61204-3 Industrial environment													

Unless otherwise noted, specifications are warranted over the ambient temperature range of 0° to 50° C.

***NOTES:**

- *1: Minimum voltage is guaranteed to maximum 0.1% of rated output voltage.
- *2: Minimum current is guaranteed to maximum 0.2% of rated output current.
- *3: GSP 10kW: Derate 10A/1°C above 40°C. GSP 15kW: Derate 15A/1°C above 40°C.
- *4: For cases where conformance to various safety standards (UL, IEC, etc...) is required, to be described as 190-240Vac (50/60Hz) for 3-Phase
- *5: 3-Phase 200V models: At 200Vac input voltage, 3-Phase 400/480V: At 380Vac input voltage. With rated output power.
- *6: Not including EMI filter inrush current, less than 0.2mSec.
- *7: 3-Phase 200V models: 170~265Vac, 3-Phase 400V models: 342~460Vac, 3-Phase 480V models: 342~528Vac. Constant load.
- *8: From No-Load to Full-Load, constant input voltage. Measured at the sensing point in Remote Sense.
- *9: For 10V~150V models: Measured with JEITA RC-9131C (1:1) probe. For 200~600V models: Measured with 100:1 probe.
- *10: The maximum voltage on the power supply terminals must not exceed the rated voltage.
- *11: From 10% to 90% or 90% to 10% of Rated Output Voltage, with rated, resistive load.
- *12: From 90% to 10% of Rated Output Voltage.
- *13: For load voltage change, equal to the unit voltage rating, constant input voltage.
- *14: For 10V model the ripple is measured at 2V and rated output current. For other models, the ripple is measured at 10% of rated output voltage. B.W 5Hz~1MHz.
- *15: The Constant Current programming, readback and monitoring accuracy do not include the warm-up and Load regulation thermal drift.
- *16: Measured at the sensing point.
- *17: For 10V model Ta derating 2°C/100m."
- *18:"Signal and control ports interface cables length: Less than 3m, DC output power port cables length: Less than 30m.
- *19:Max. ambient temperature for using IEEE is 40°C.
- *20:GSP10kW For 10V model only: Max. output current for using IEEE is 800A up to 40°C and 900A up to 30°C.
- *20:GSP15kW For 10V model only: Max. output current for using IEEE is 1200A up to 40°C and 1350A up to 30°C.
- *21: For 10V model only: For 3-Phase 200V efficiency is 88.5%
- *22: Typ. at Ta=25°C, rated output power.
- *23: For steady state only.

Outline Drawing GENESYS™ G1kW/1.7kW/2.7kW/3.4kW - 1-Phase

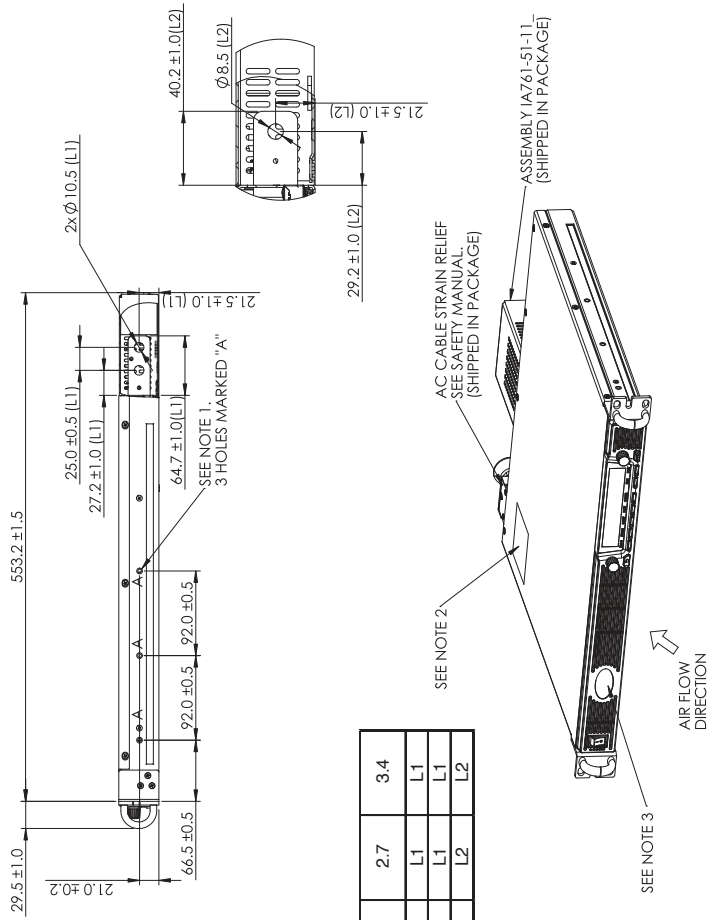
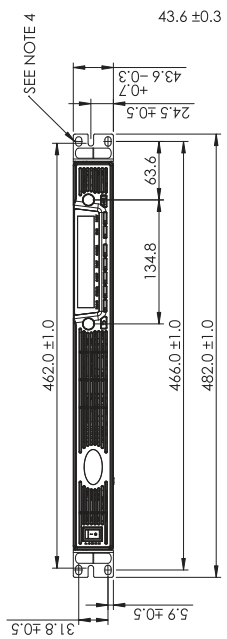
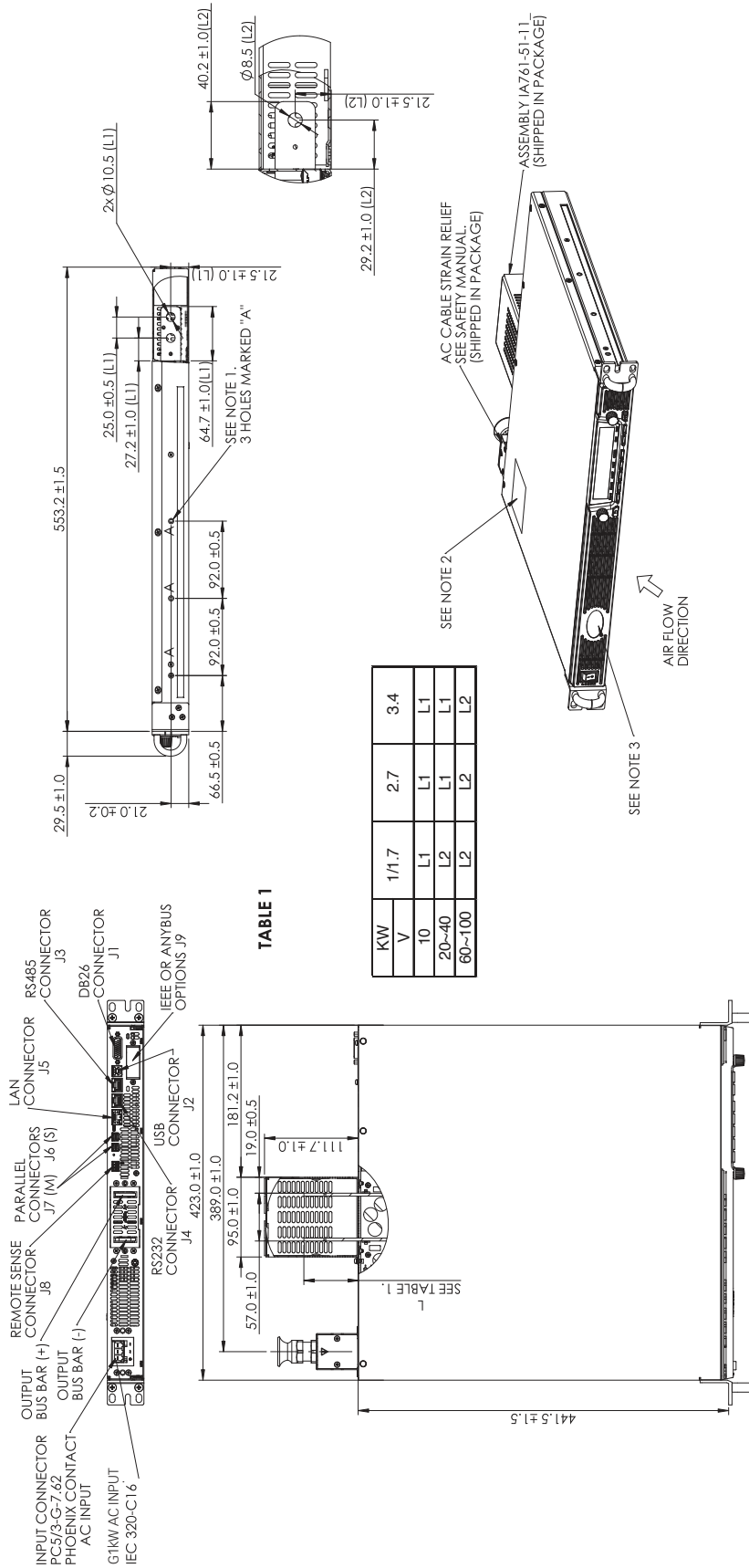

- NOTE**
1. MOUNTING HOLES FOR SLIDES P/INC3001-00-S160, GENERAL DEVICES OR EQUIVALENT. USE #10-32x0.38INCH x3 SCREWS FOR EACH SLIDE. ENSURE THAT THE SCREWS DO NOT PENETRATE MORE THAN 6.0mm INTO THE UNIT.
 2. AC INPUT RATING, SAFETY APPROVAL SYMBOLS AND EU REPRESENTATIVE ADDRESS LABEL ARE SHOWN HERE ACCORDING TO THE SPECIFICATIONS.
 3. MODEL NAME, OUTPUT RATING AND COMPANY LOGO ARE SHOWN HERE ACCORDING TO THE SPECIFICATIONS.
 4. MOUNTING HOLES FOR 19" RACK, USE M6x1.6 SCREWS TO FIX THE UNIT TO THE RACK.

Outline Drawing GENESYS™ G2.7kW/G3.4kW/G5kW - 3-Phase

(Not includes G+5kW models: 1000V & 1500V).

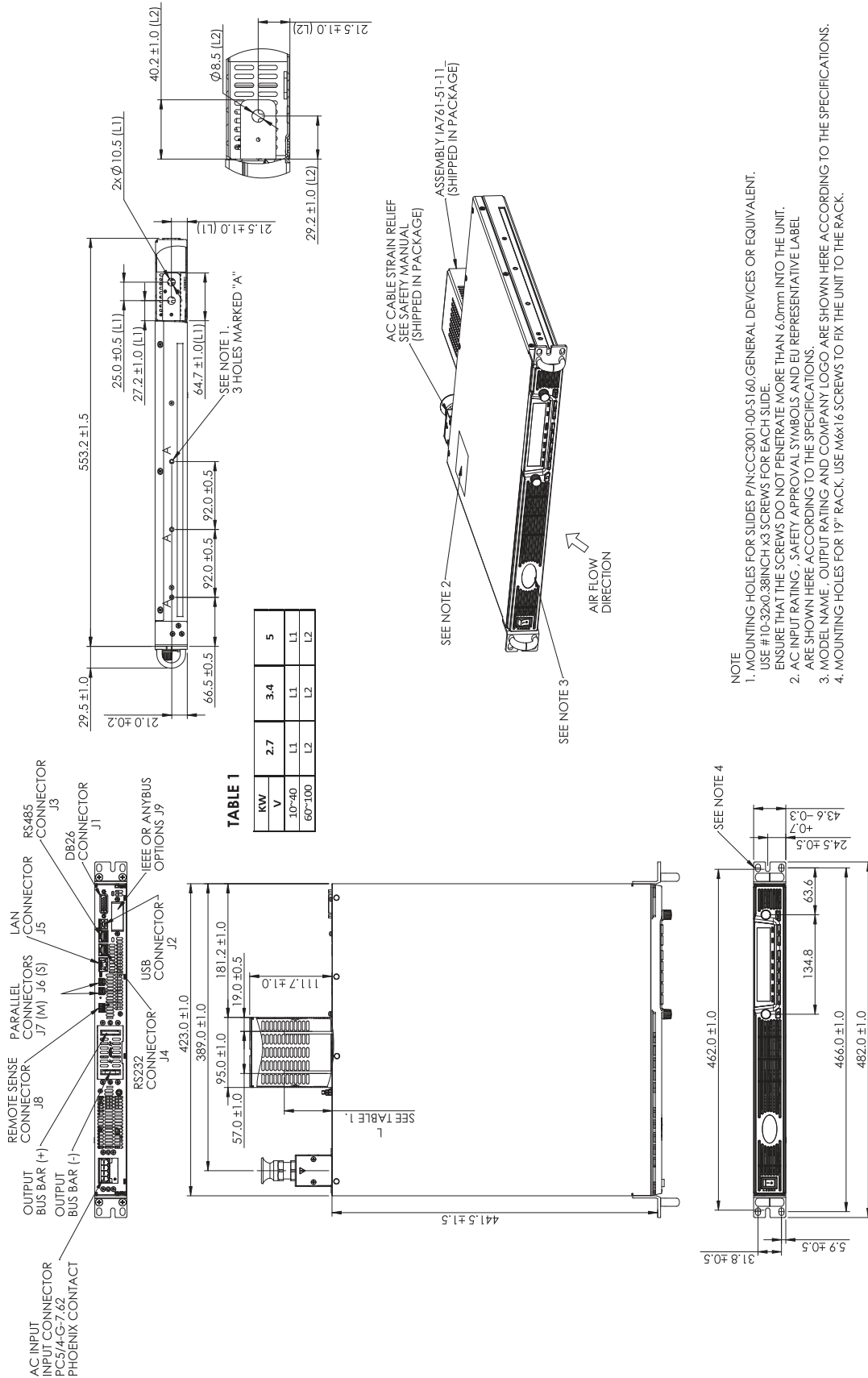

Outline Drawing GENESYS™ GB1kW/1.7kW/GB2.7kW/GB3.4kW/GB5kW - ATE Version

(Not includes G+5kW models: 1000V & 1500V).

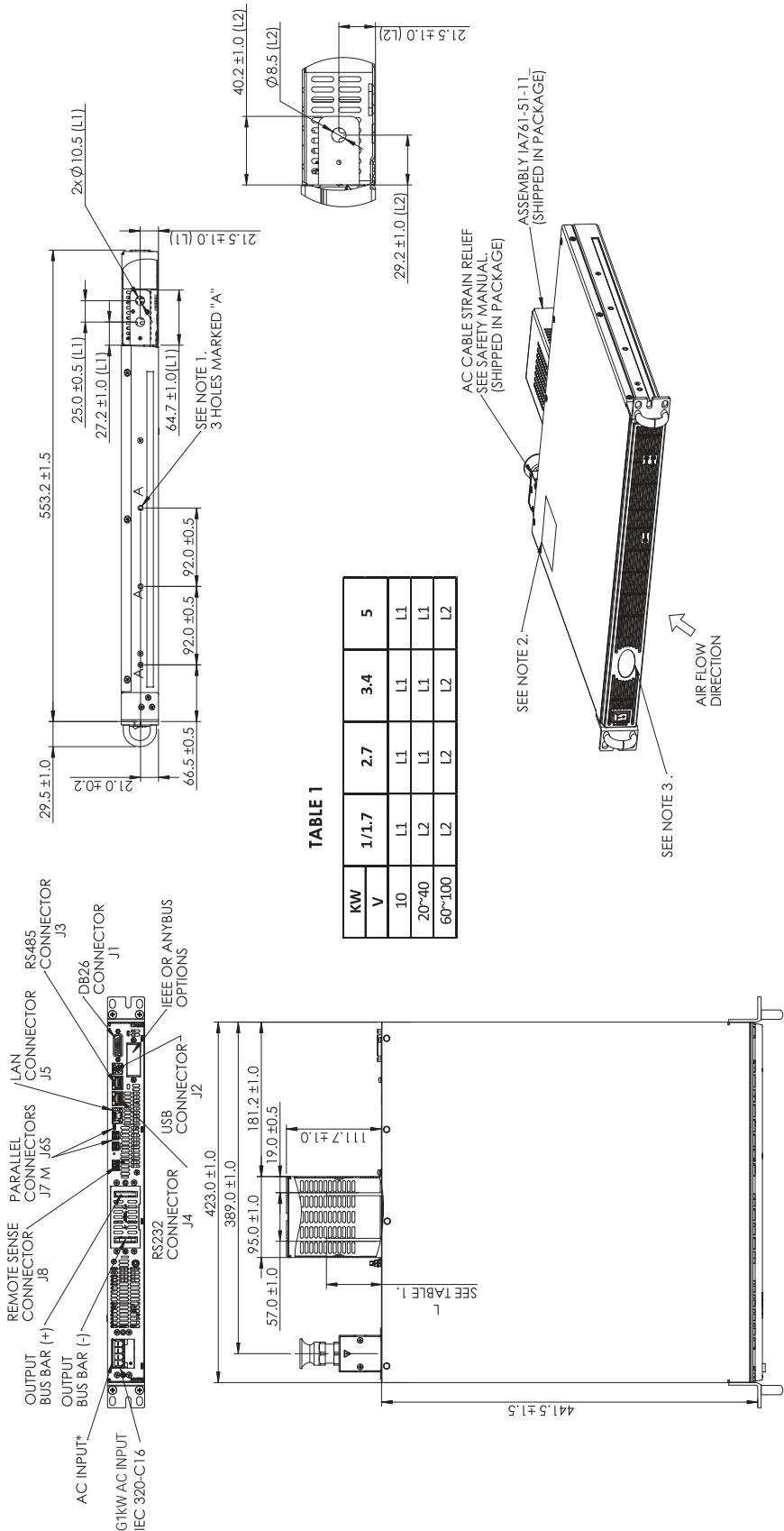
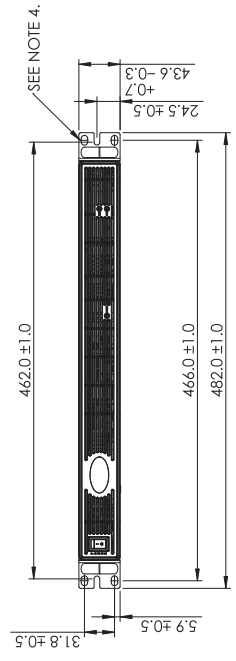
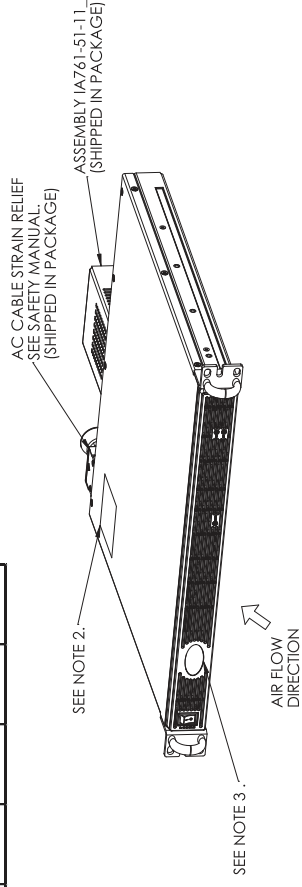
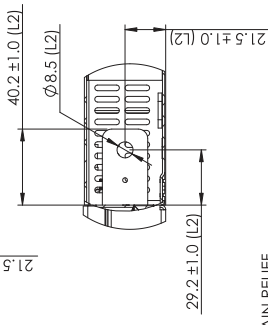
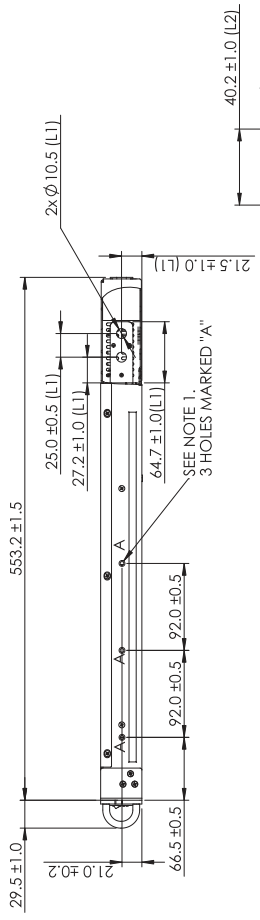

TABLE 1

KW	1/1.7	2.7	3.4	5
V	L1	L1	L1	L1
10	L1	L1	L1	L1
20~40	L2	L1	L1	L1
60~100	L2	L2	L2	L2



* FOR MODEL WITH 3PHASE AC INPUT CONNECTOR PCS/4-G-7.62 (PHOENIX CONTACT).
 FOR MODEL WITH 1PHASE AC INPUT CONNECTOR PCS/3-G-7.62 (PHOENIX CONTACT)

NOTE
 1. MOUNTING HOLES FOR SLIDES P/N:CC3001-00.S160, GENERAL DEVICES OR EQUIVALENT.
 USE #10-32X0.38INCH X3 SCREWS FOR EACH SLIDE.
 ENSURE THAT THE SCREWS DO NOT PENETRATE MORE THAN 6.0mm INTO THE UNIT.
 2. AC INPUT RATING, SAFETY APPROVAL SYMBOLS AND EU REPRESENTATIVE ADDRESS LABEL ARE SHOWN HERE ACCORDING TO THE SPECIFICATIONS.
 3. MODEL NAME, OUTPUT RATING AND COMPANY LOGO ARE SHOWN HERE ACCORDING TO THE SPECIFICATIONS.
 4. MOUNTING HOLES FOR 19" RACK. USE M6x16 SCREWS TO FIX THE UNIT TO THE RACK.

Outline Drawing **GENESYS™** G7.5kW - LV (20V-100V) 3-Phase

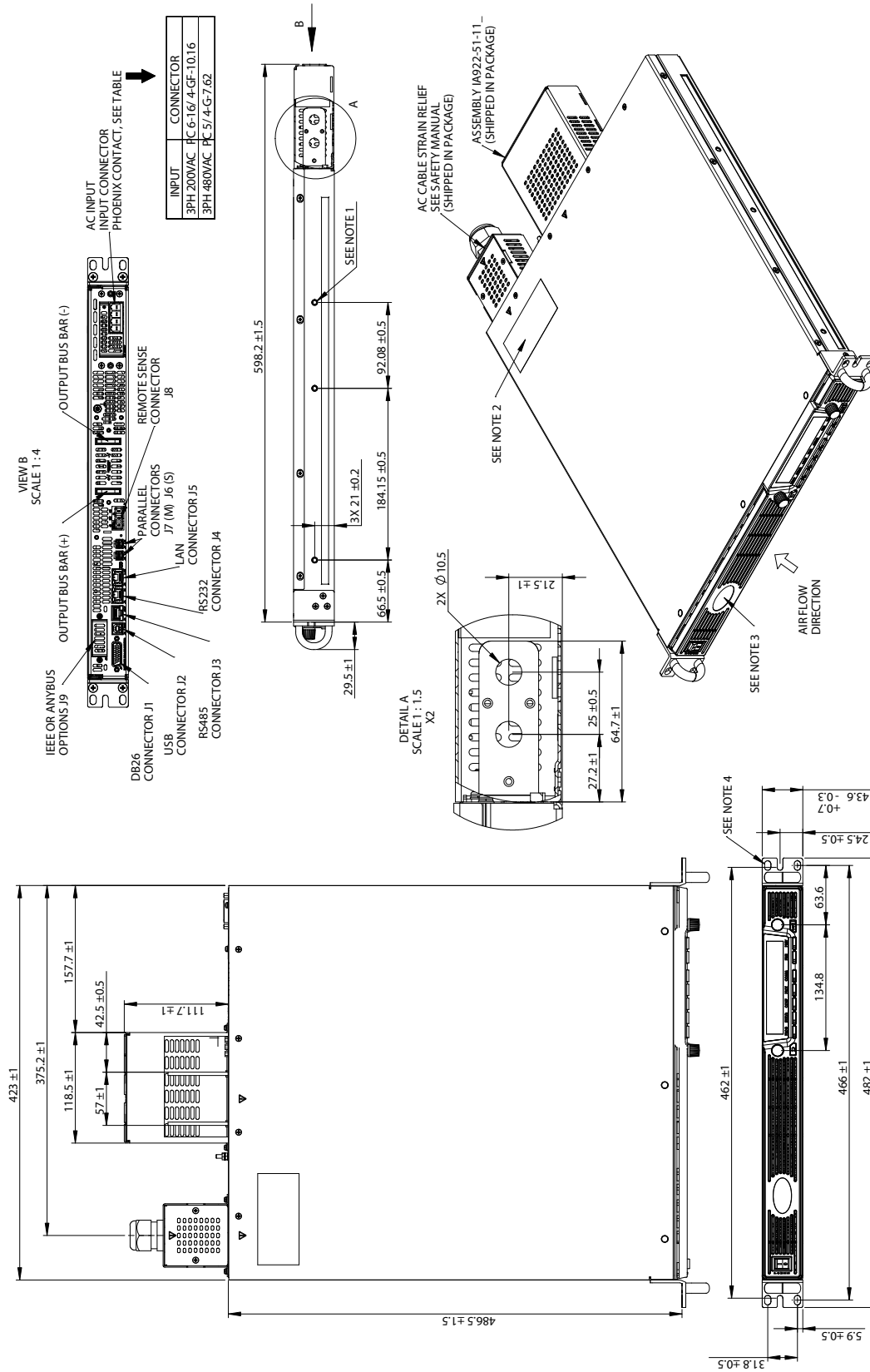

INPUT	CONNECTOR
3PH 200VAC	PC 6-16/ 4-GF-10.16
3PH 480VAC	PC 5/ 4-G-7.62

G+7.5KW 20V~100V

- NOTE
1. MOUNTING HOLES FOR SLIDES P/NK3001-00-5160 GENERAL DEVICES OR EQUIVALENT. USE #10-32x0.375 INCH x 3 SCREWS FOR EACH SLIDE. ENSURE THAT THE SCREWS DO NOT PENETRATE MORE THAN 6.0mm INTO THE UNIT.
 2. AC INPUT RATING - SAFETY APPROVAL SYMBOLS AND EU REPRESENTATIVE LABEL ARE SHOWN HERE ACCORDING TO THE SPECIFICATIONS.
 3. MODEL NAME, OUTPUT RATING AND COMPANY LOGO ARE SHOWN HERE ACCORDING TO THE SPECIFICATIONS.
 4. MOUNTING HOLES FOR 19" RACK. USE M6x16 SCREWS TO FIX THE UNIT TO THE RACK.

Outline Drawing GENESYS™ G7.5kW - HV (150V-1500V) 3-Phase

(includes G+5kW models: 1000V & 1500V).

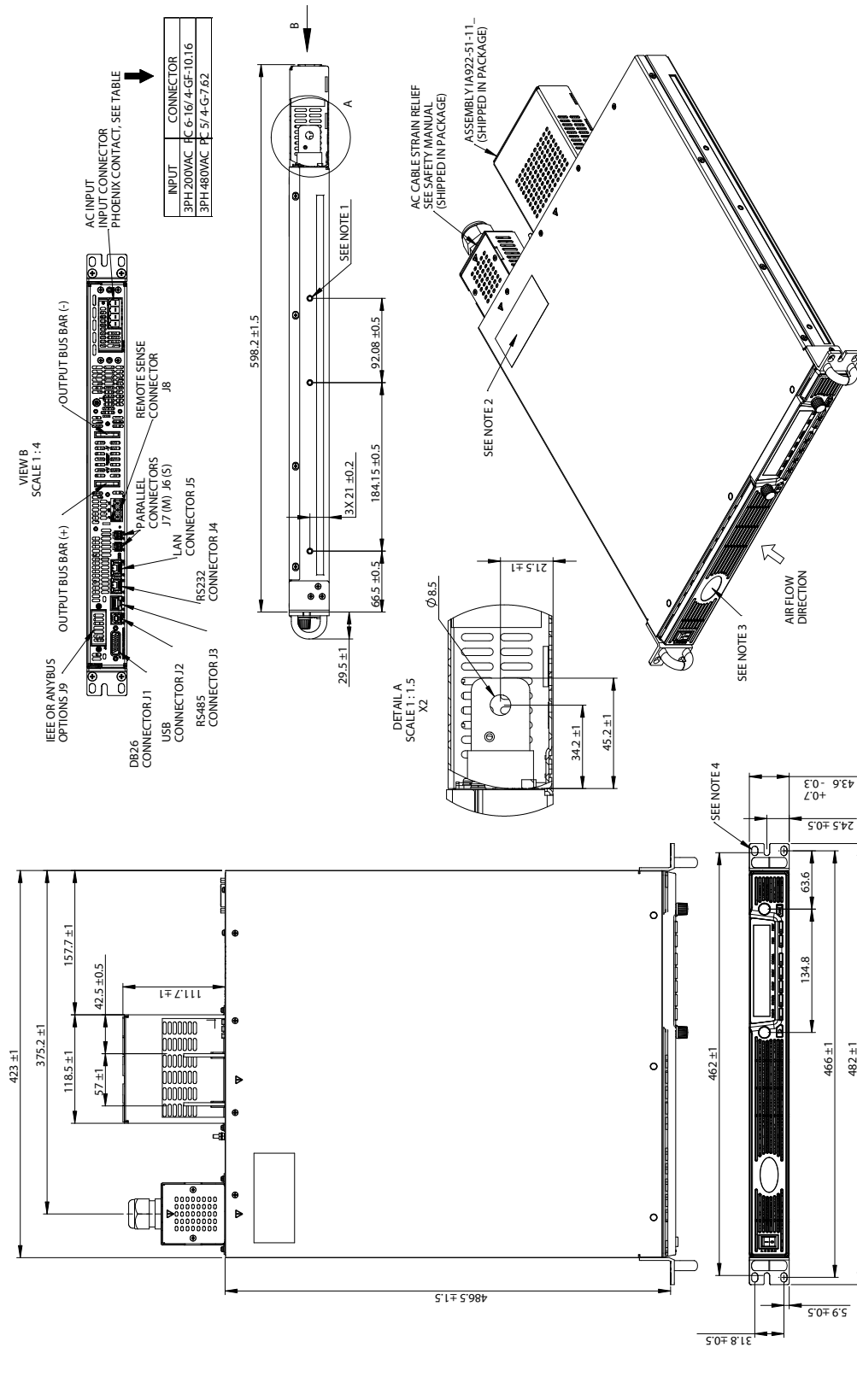

G+7.5KW 150V~1500V

- NOTE**
1. MOUNTING HOLES FOR SLIDES P/NCC3001-00-S160 GENERAL DEVICES OR EQUIVALENT. USE #10-32x0.325 INCH x 3 SCREWS FOR EACH SLIDE. ENSURE THAT THE SCREWS DO NOT PENETRATE MORE THAN 6.0mm INTO THE UNIT.
 2. AC INPUT RATING, SAFETY APPROVAL SYMBOLS AND EU REPRESENTATIVE LABEL ARE SHOWN HERE ACCORDING TO THE SPECIFICATIONS.
 3. MODEL NAME, OUTPUT RATING AND COMPANY LOGO ARE SHOWN HERE ACCORDING TO THE SPECIFICATIONS.
 4. MOUNTING HOLES FOR 19" RACK, USE M6x16 SCREWS TO FIX THE UNIT TO THE RACK.

Outline Drawing GENESYS™ GB7.5kW ATE Version

(includes G+5kW models: 1000V & 1500V).

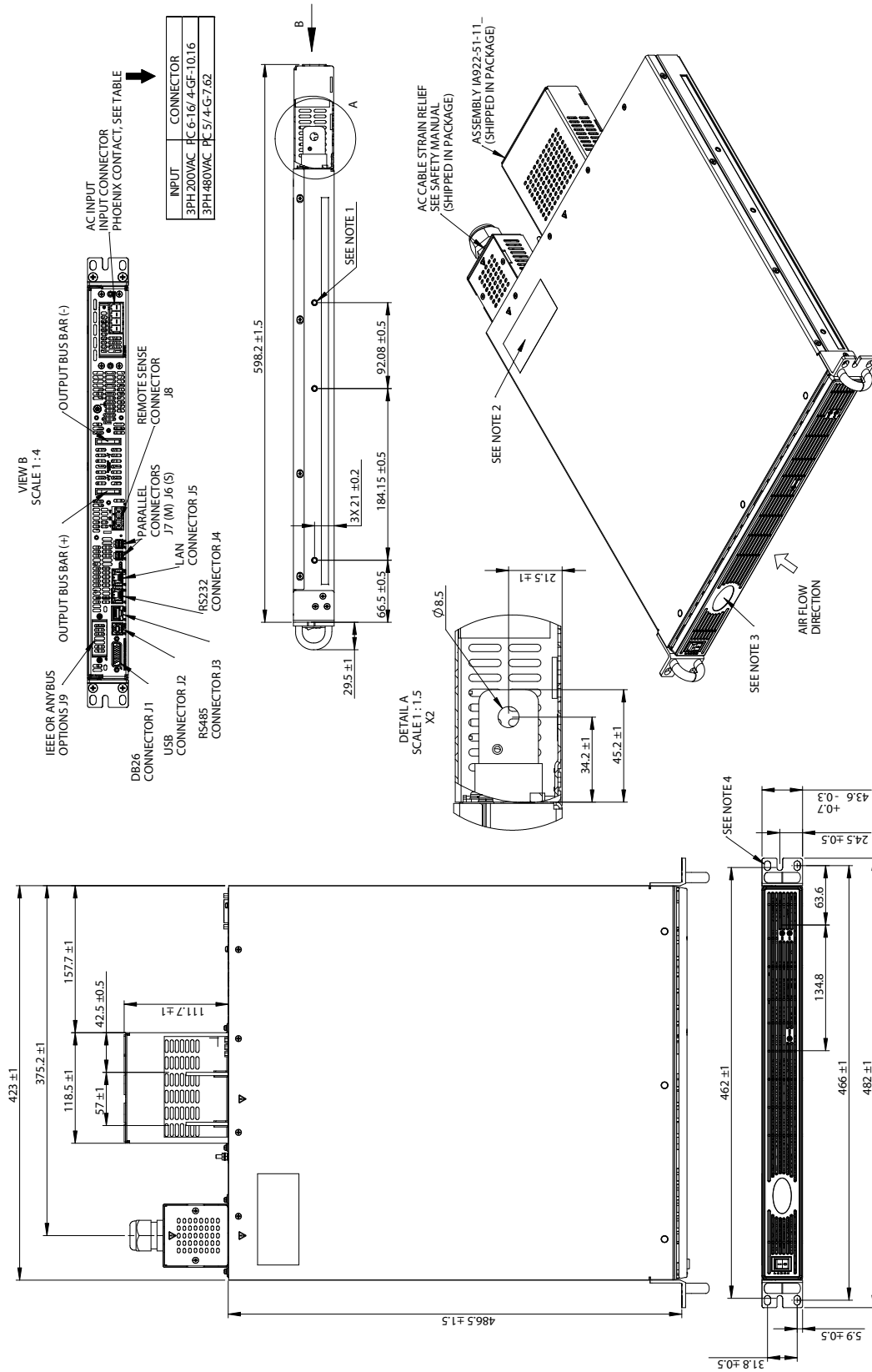

G+7.5KW BLANK 150V-1500V

Outline Drawing GENESYS™ GSP10kW

(includes G+5kW models: 1000V & 1500V).

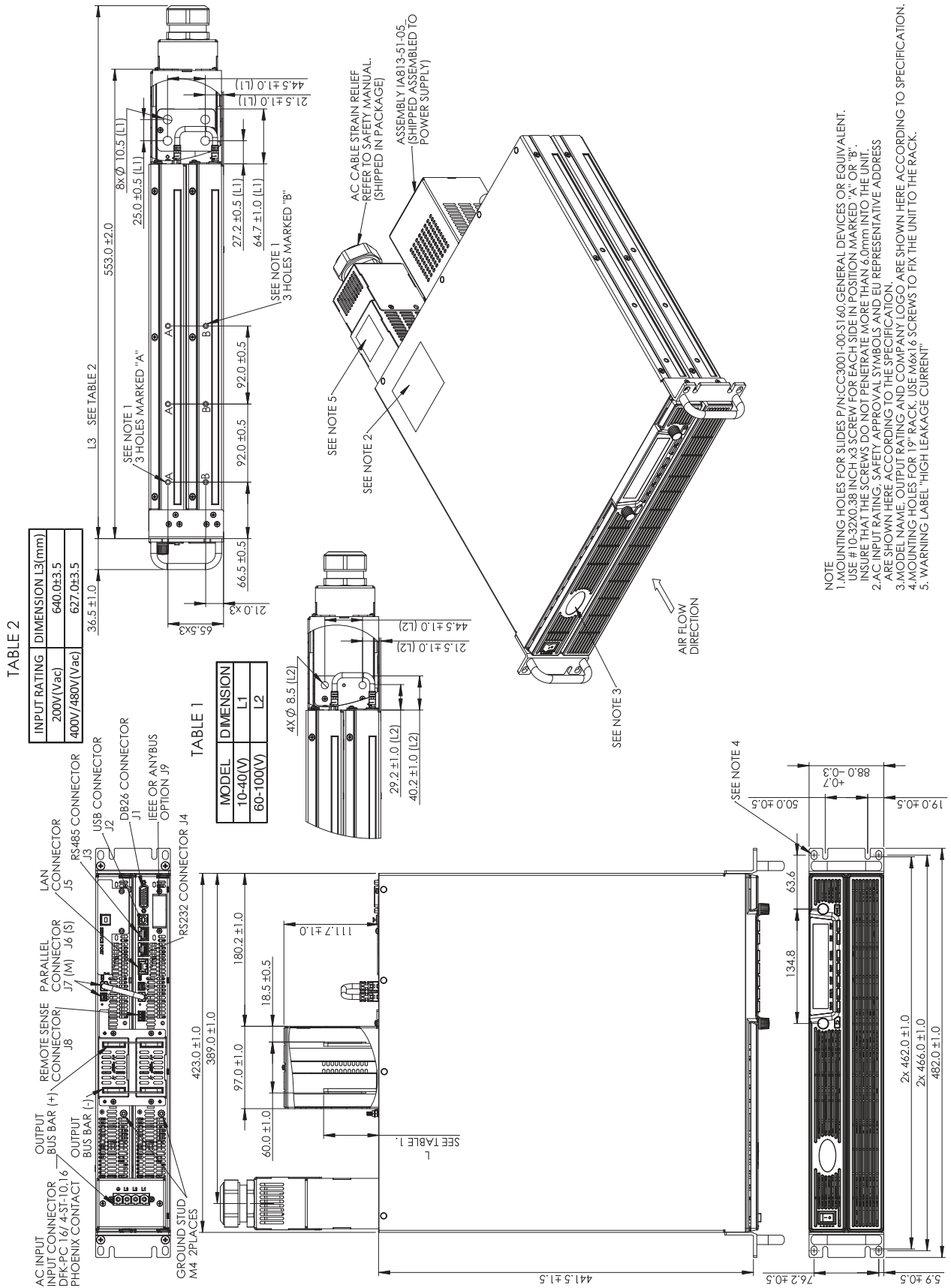

NOTE

1. MOUNTING HOLES FOR SLIDES P/N/CC3001-00-S160 GENERAL DEVICES OR EQUIVALENT. USE #10-32X0.38 INCH X3 SCREW FOR EACH SIDE IN POSITION MARKED "A" OR "B". INSURE THAT THE SCREWS DO NOT PENETRATE MORE THAN 6.0mm INTO THE UNIT.
2. AC INPUT RATING, SAFETY APPROVAL SYMBOLS AND EU REPRESENTATIVE ADDRESS ARE SHOWN HERE ACCORDING TO THE SPECIFICATION.
3. MODEL NAME, OUTPUT RATING AND COMPANY LOGO ARE SHOWN HERE ACCORDING TO SPECIFICATION.
4. MOUNTING HOLES FOR 19" RACK. USE M6x1.6 SCREWS TO FIX THE UNIT TO THE RACK.
5. WARNING LABEL "HIGH LEAKAGE CURRENT"

Outline Drawing **GENESYS™** GSP15kW

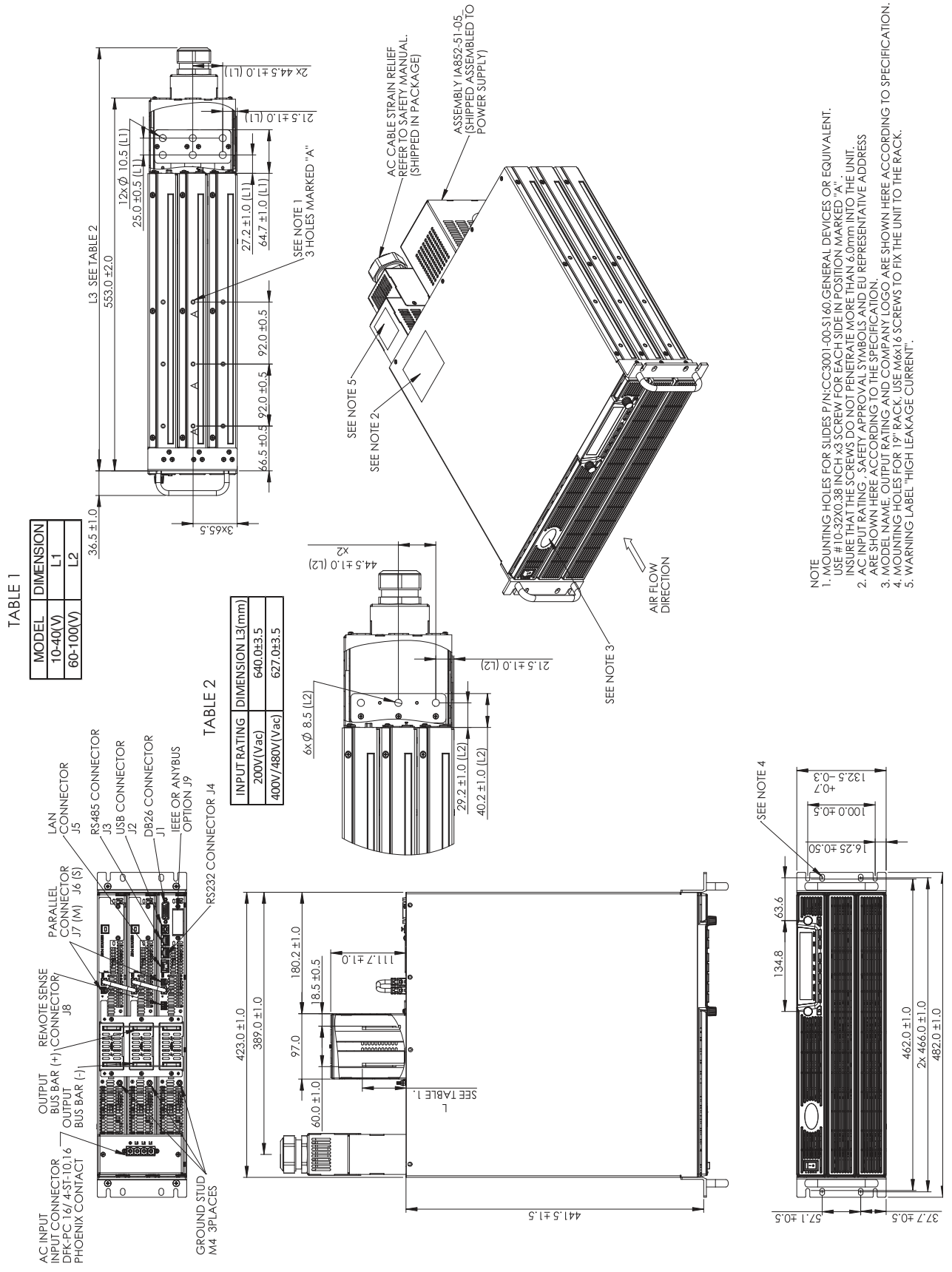
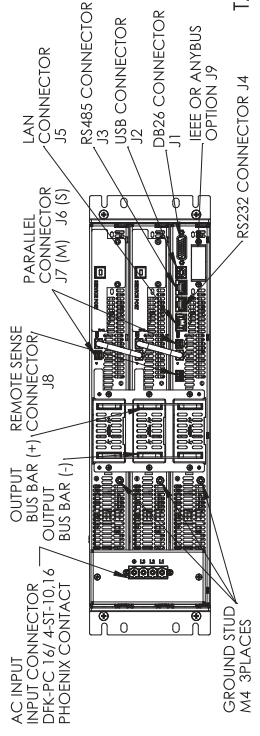

TABLE 1

MODEL	DIMENSION
10-40(V)	L1
60-100(V)	L2

TABLE 2

INPUT RATING	DIMENSION L3(mm)
200V(Vac)	640.0±3.5
400V/480V(Vac)	627.0±3.5



- NOTE
1. MOUNTING HOLES FOR SLIDES P/N:CC3001-00-S160, GENERAL DEVICES OR EQUIVALENT. USE # 10-32X0.38 INCH X3 SCREW FOR EACH SIDE IN POSITION MARKED "A". INSURE THAT THE SCREWS DO NOT PENETRATE MORE THAN 6.0mm INTO THE UNIT.
 2. AC INPUT RATING, SAFETY APPROVAL SYMBOLS AND EU REPRESENTATIVE ADDRESS ARE SHOWN HERE ACCORDING TO THE SPECIFICATION.
 3. MODEL NAME, OUTPUT RATING AND COMPANY LOGO ARE SHOWN HERE ACCORDING TO SPECIFICATION.
 4. MOUNTING HOLES FOR 19" RACK. USE M6X16 SCREWS TO FIX THE UNIT TO THE RACK.
 5. WARNING LABEL "HIGH LEAKAGE CURRENT".

Outline Drawing **GENESYS™** Air Filter Kit

BLANK AIR FILTER (GB-AFK)

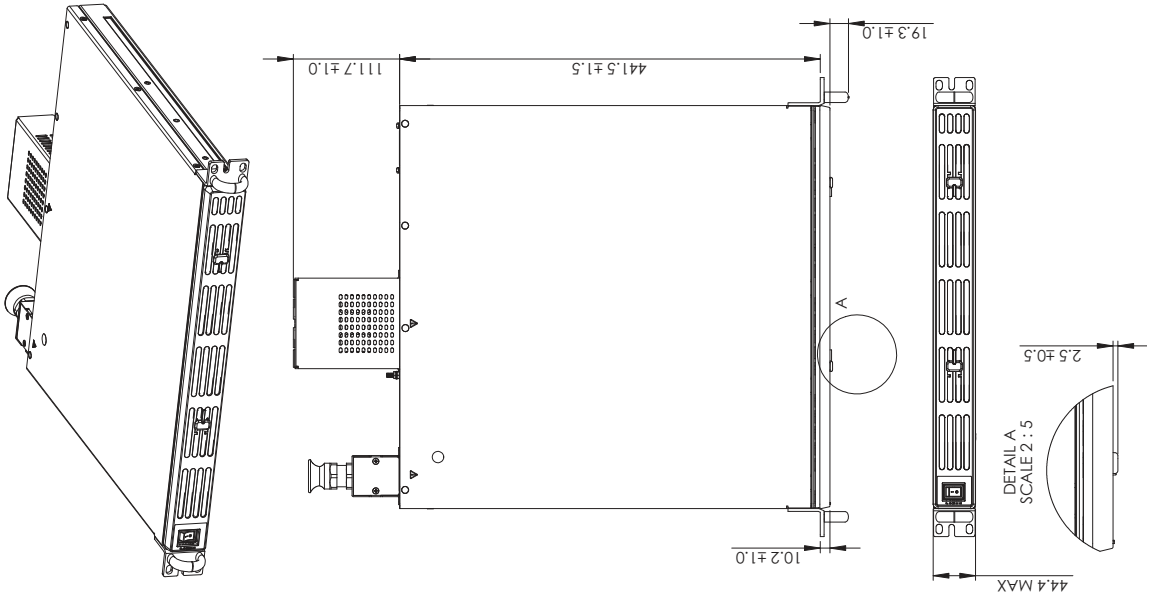

STANDARD AIR FILTER (G-AFK)

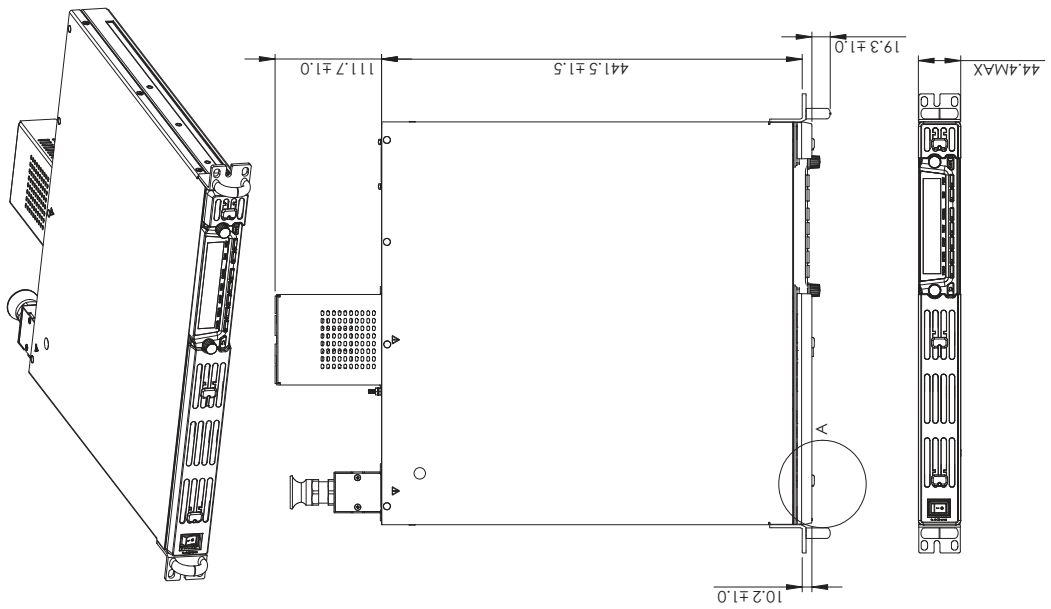

Front Panel Air Filter Assembly

Front panel dust cover is available for dusty air environment applications

Dust cover is removable snap-in filter (for easy maintenance)

- Part Number (for standard unit) : **G-AFK**



- Part Number (for unit with blank front panel) : **GB-AFK**

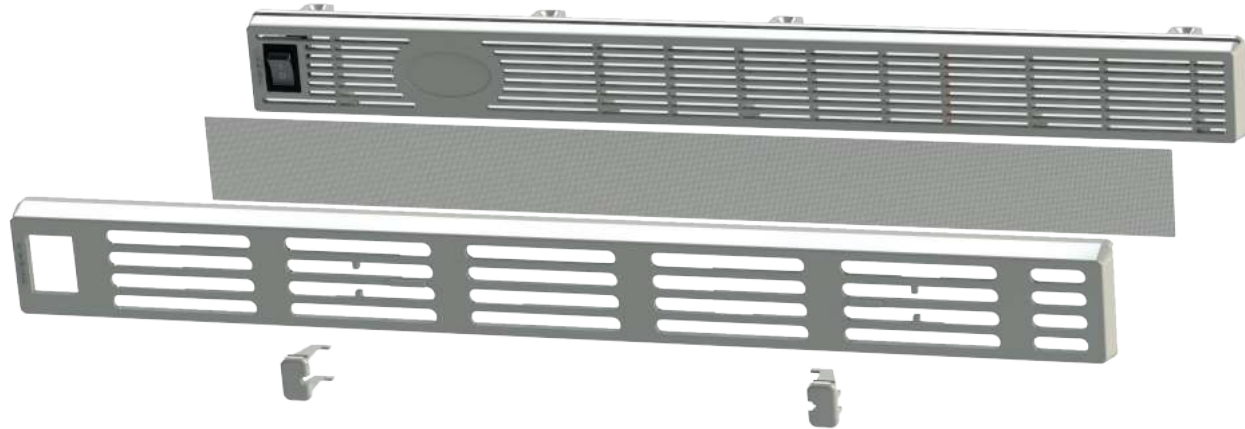

For GSP 10kW/15kW series order part number: GSP10kW-AFK / GSP15kW-AFK

Accessories

1. Front Panel dust filter / Field installation kit:

Technical Specifications: Unit with Air Filter Assembly Installed

- Derating (environmental):
- Operating Temperature
- For all models (except 10V): 0°C to +40°C full load; For 10V model: 0°C to +30°C, derate 5A/°C for 30°C < Ta < +40°C
- Altitude
- For all models (except 10V): derate 2°C/100m or 2% of load/100m (above 2000m)
- For 10V model: derate 1°C/100m or 2% of load/100m (above 2000m)

Filter Foam Technical Specifications

- Material: reticulated polyurethane foam
- Thickness: 3.8 mm
- Porosity: 45ppi
- Operating Temperature Range: 0°C to +60°C
- Storage Temperature Range: -40°C to +85°C
- Humidity: 95% RH

Air Filter Assembly Components

- Standard Unit (P/N: G-AFK)
- Air Filter Cover (two pieces)
- Slide Button #1 (two locations: near AC ON/OFF switch and near left-hand side of front panel display)
- Slide Button #2 (one location: right-hand side of front panel display)
- Filter foam (two pieces)

Blank Front Panel Unit (P/N: GB-AFK)

- Air Filter Cover (one piece)
- Slide Button #1 (two locations) • Filter foam (one piece)

TDK·Lambda

GLOBAL NETWORK

Trusted • Innovative • Reliable

<https://product.tdk.com/en/power>
www.emea.lambda.tdk.com